

Mike sauna

1/18

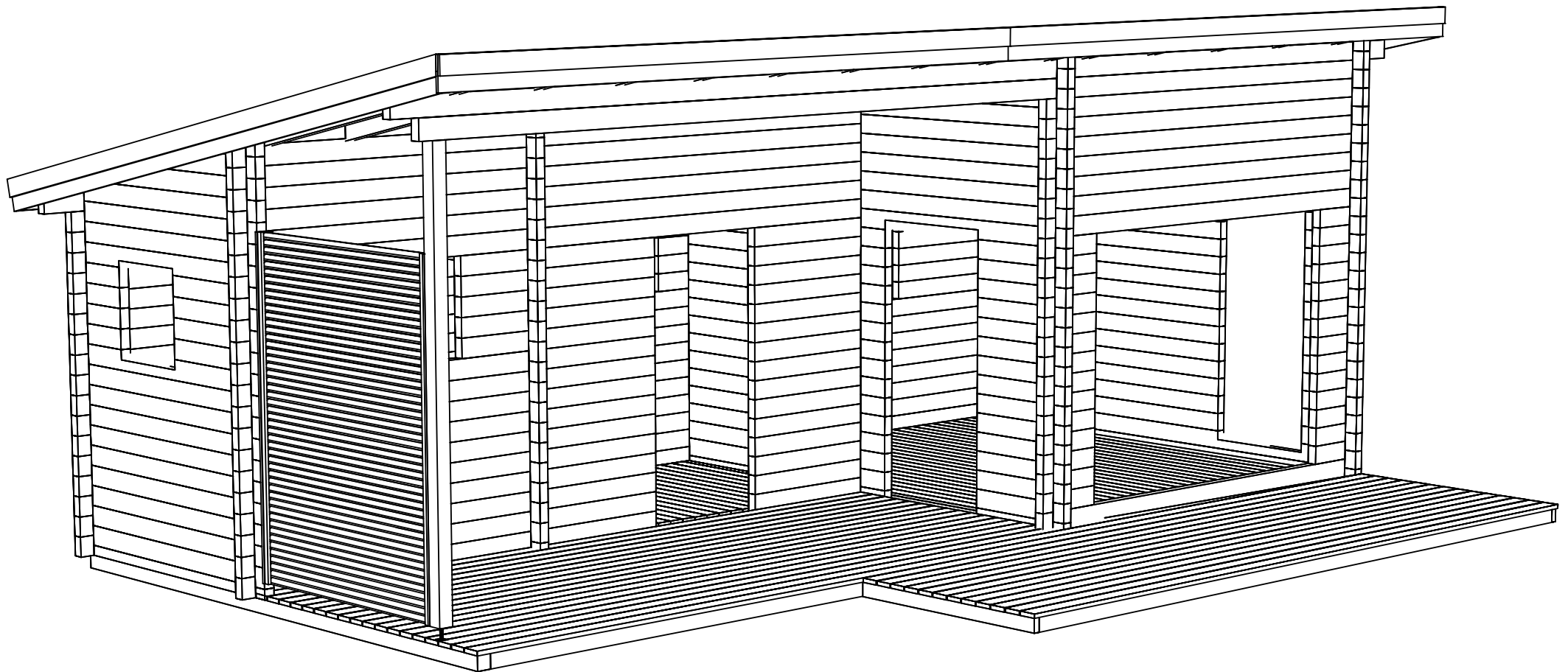

GROUND PLAN

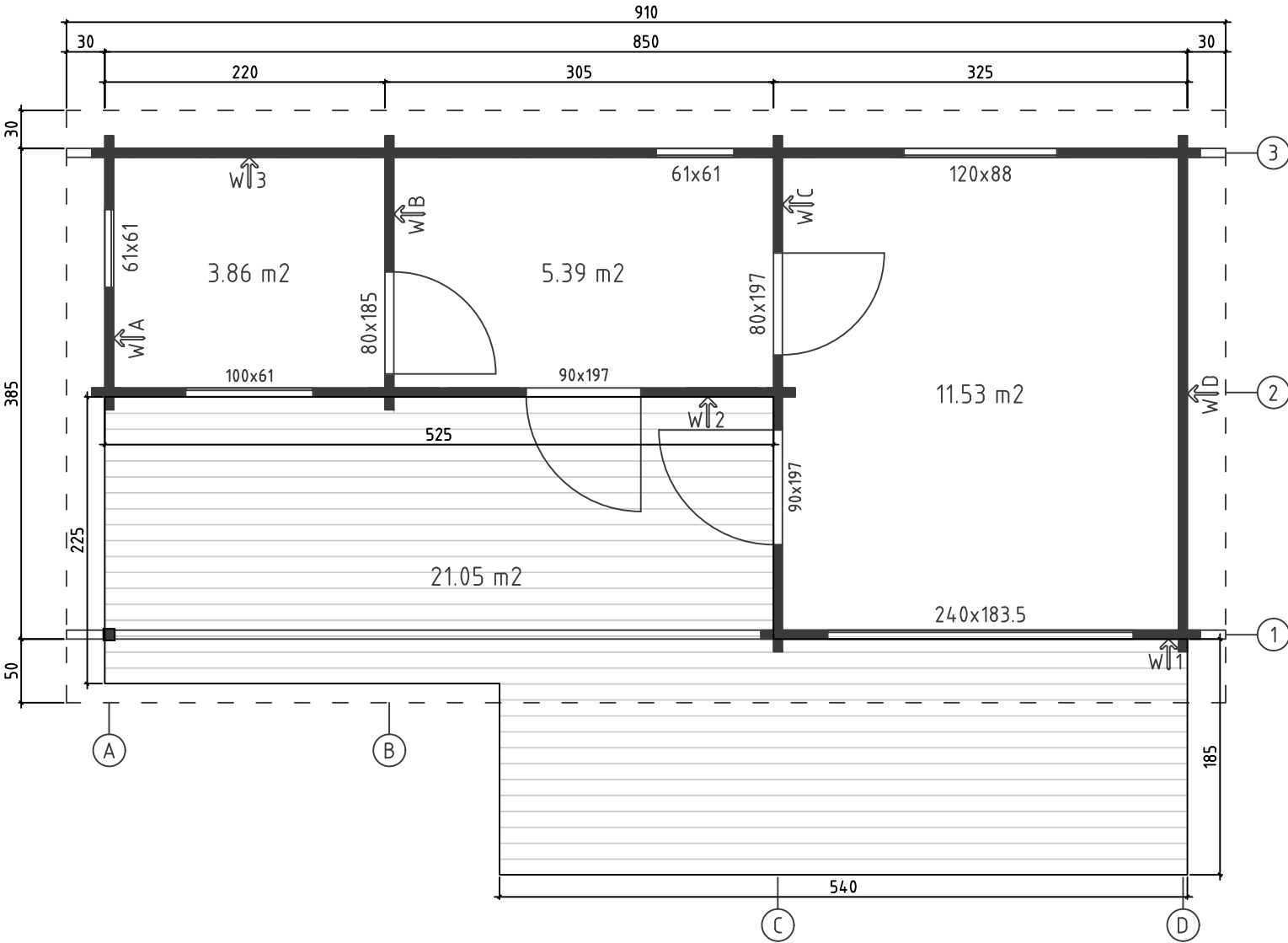

FLOOR AND TERRACE BOARDS

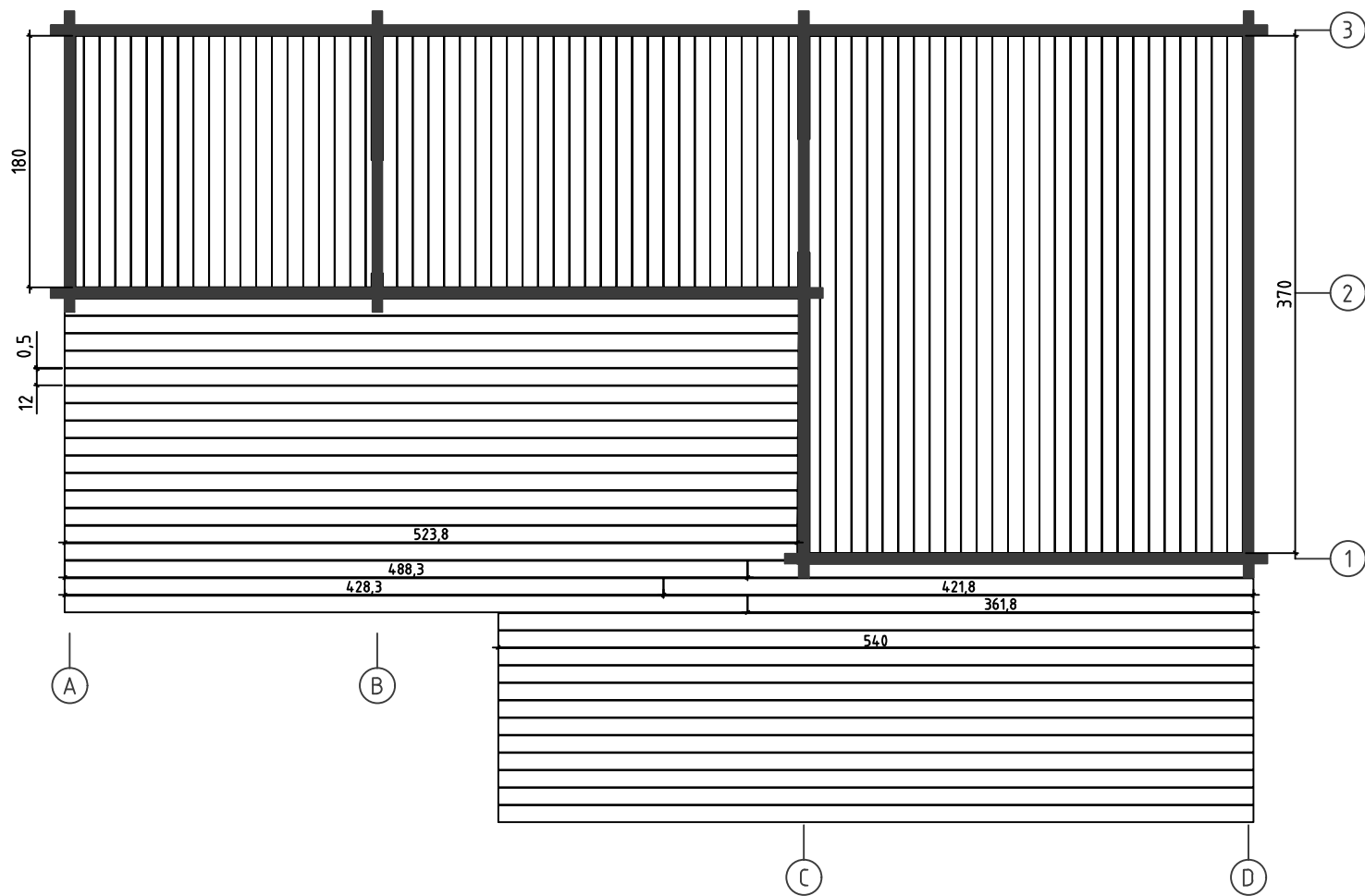

GROUND PLAN

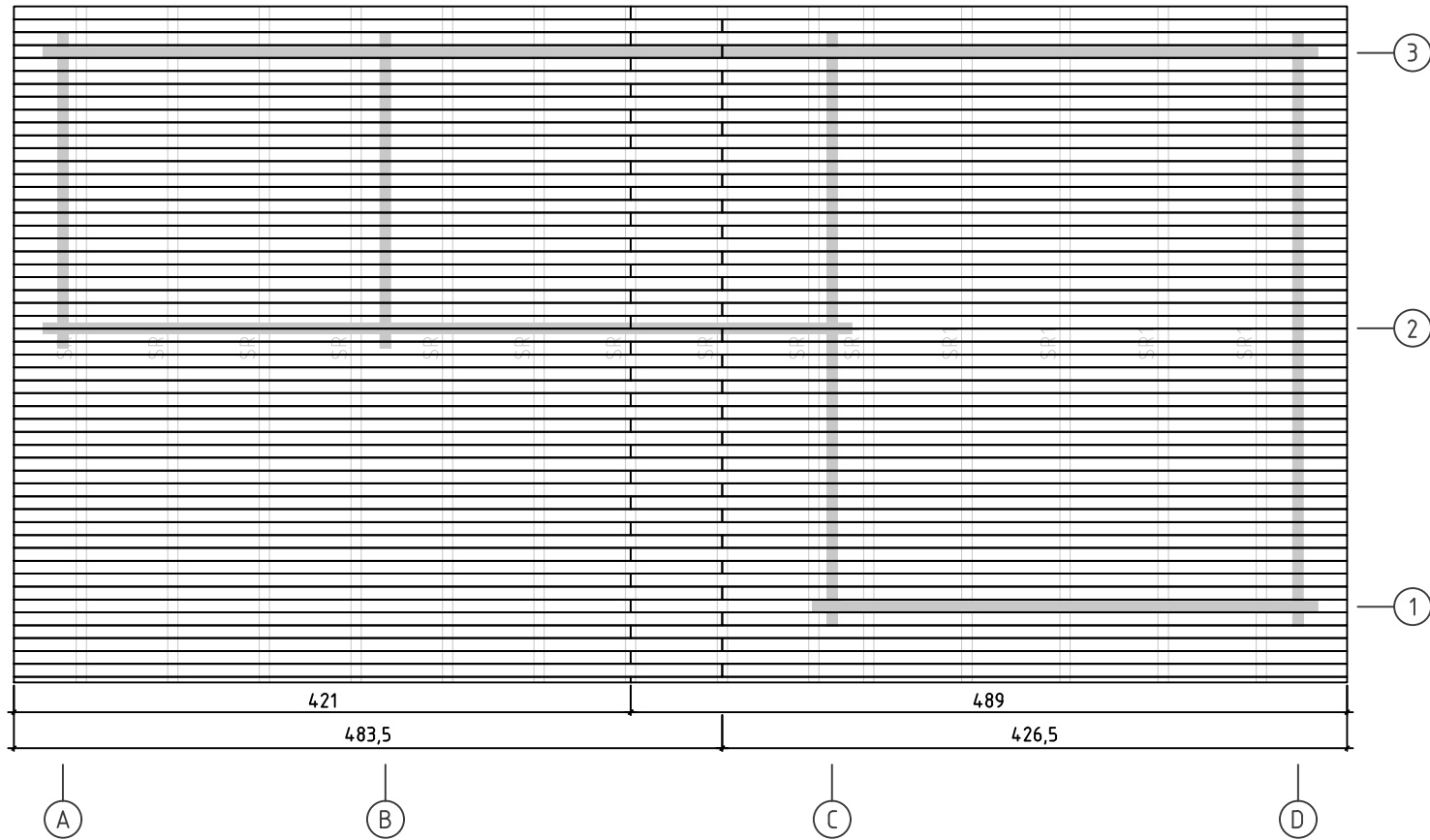

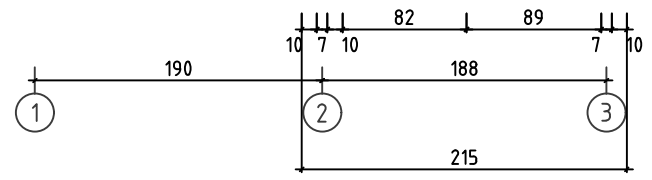
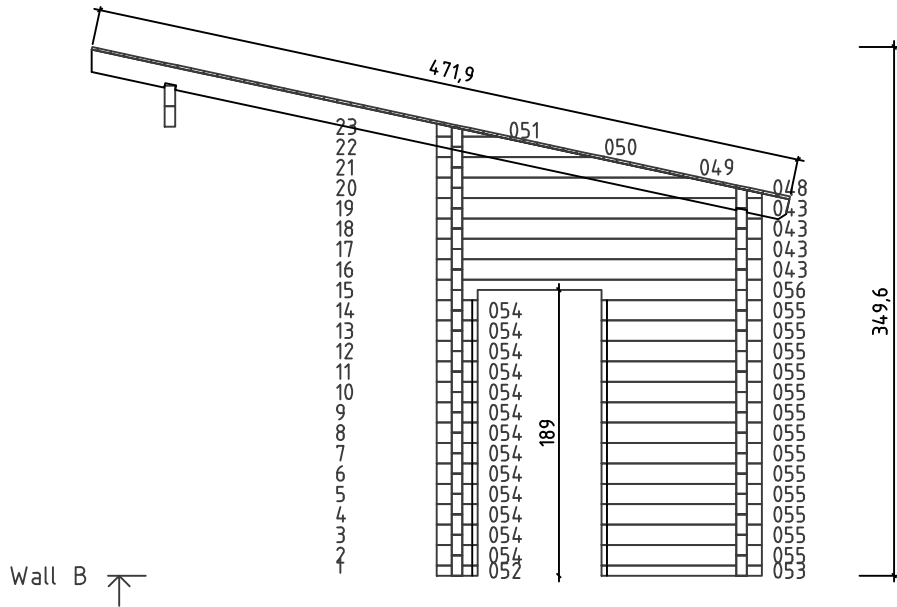
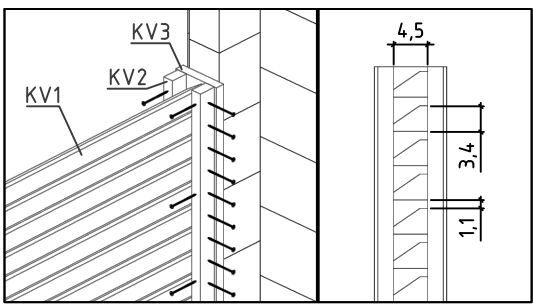
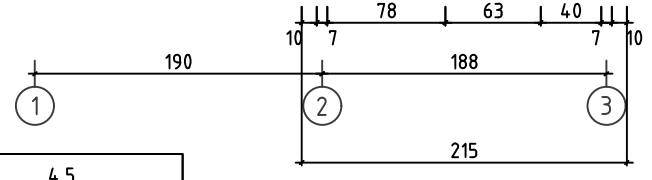
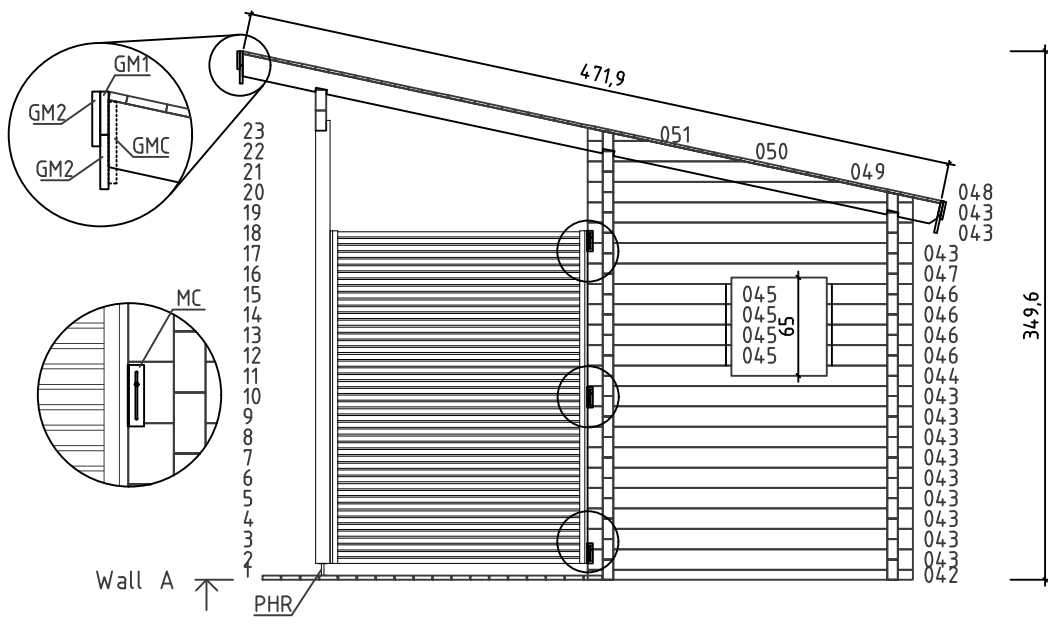

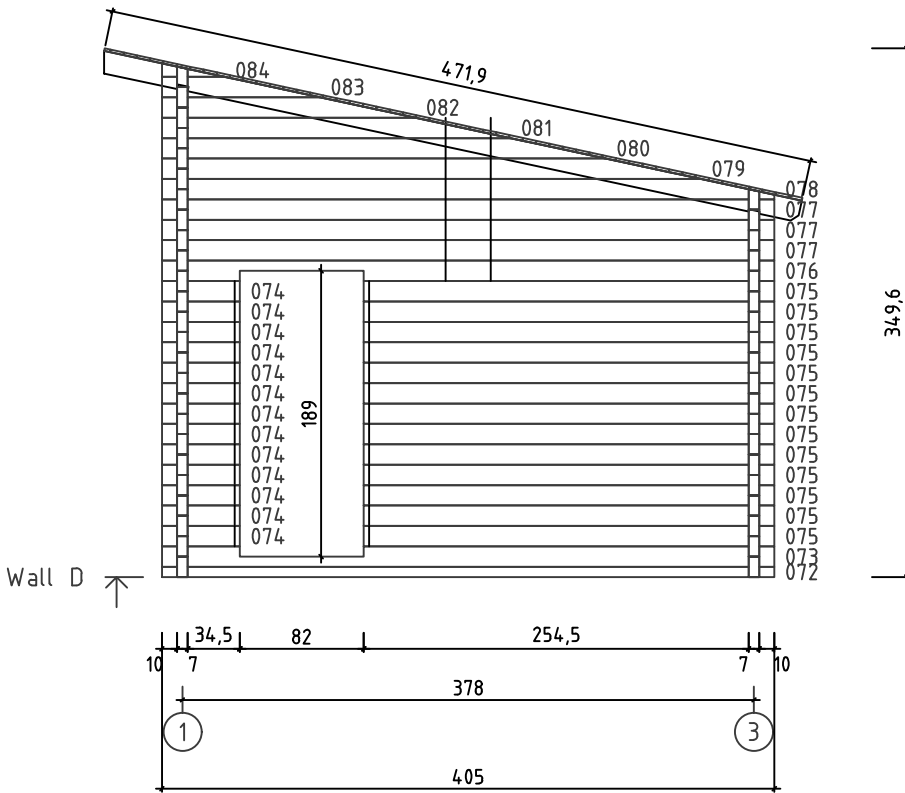
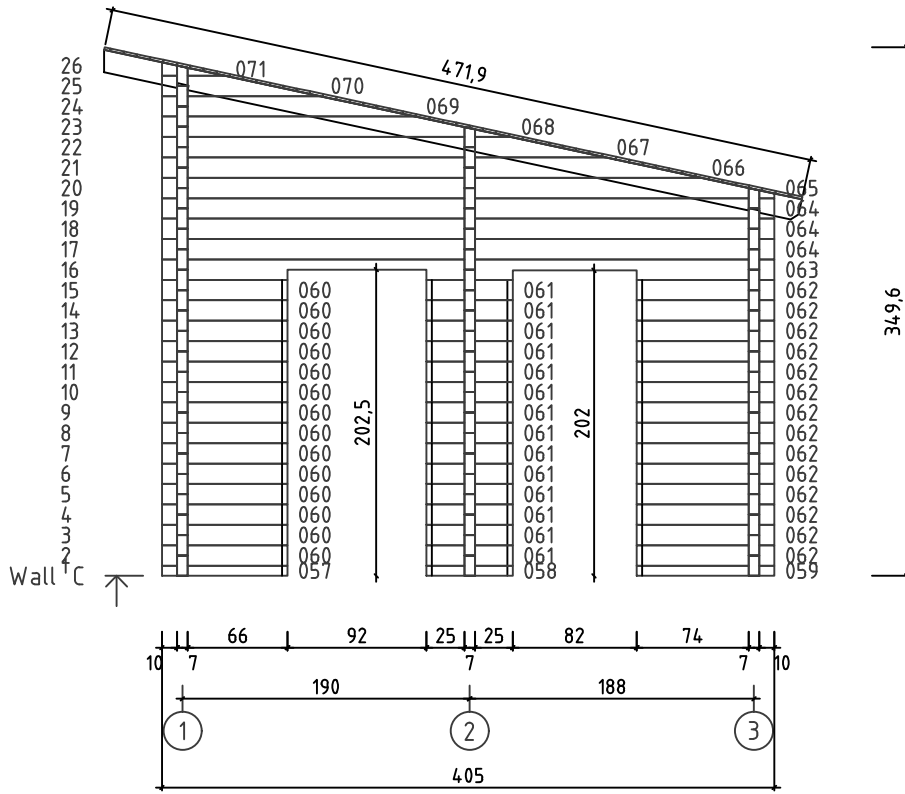

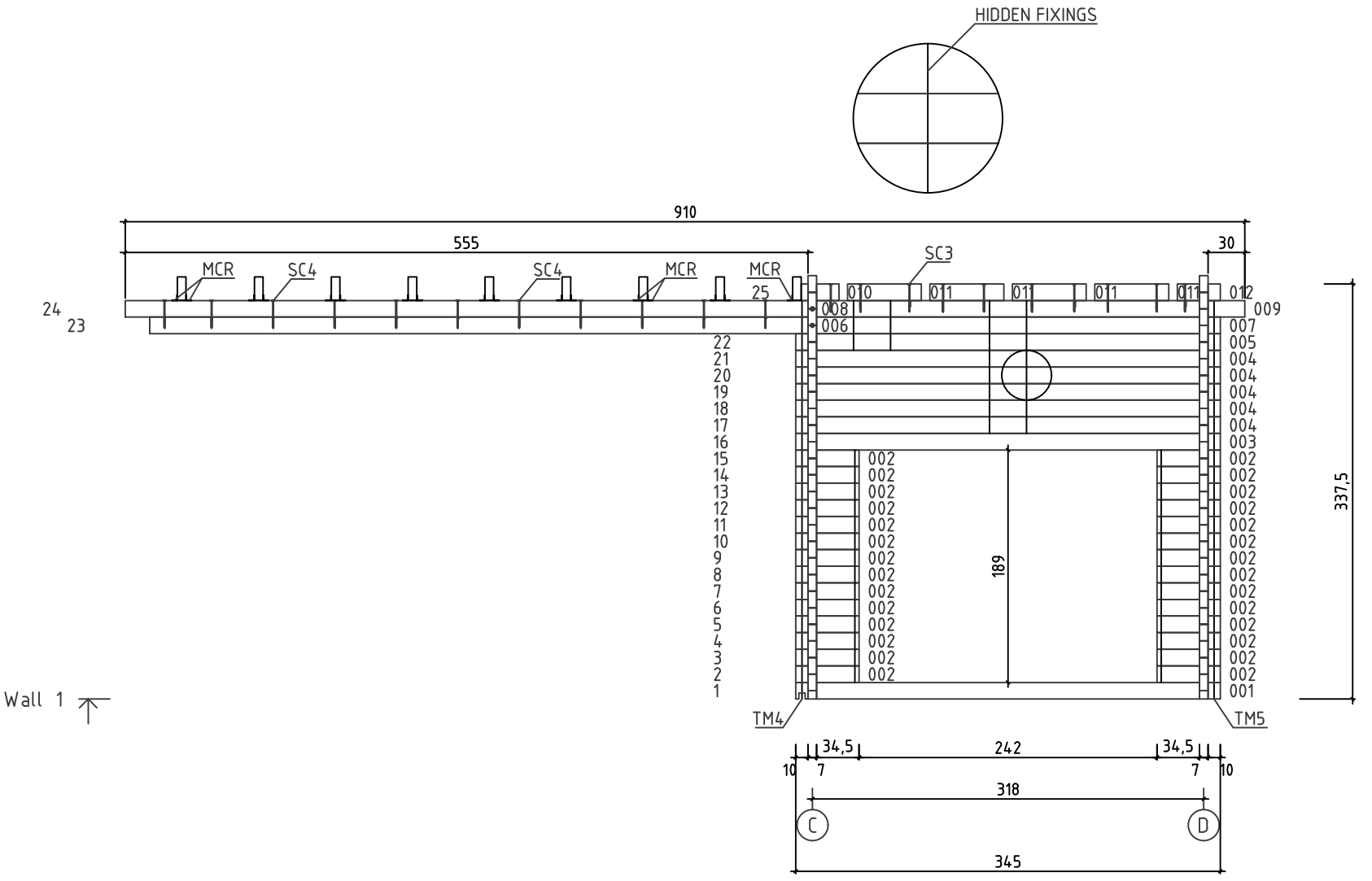

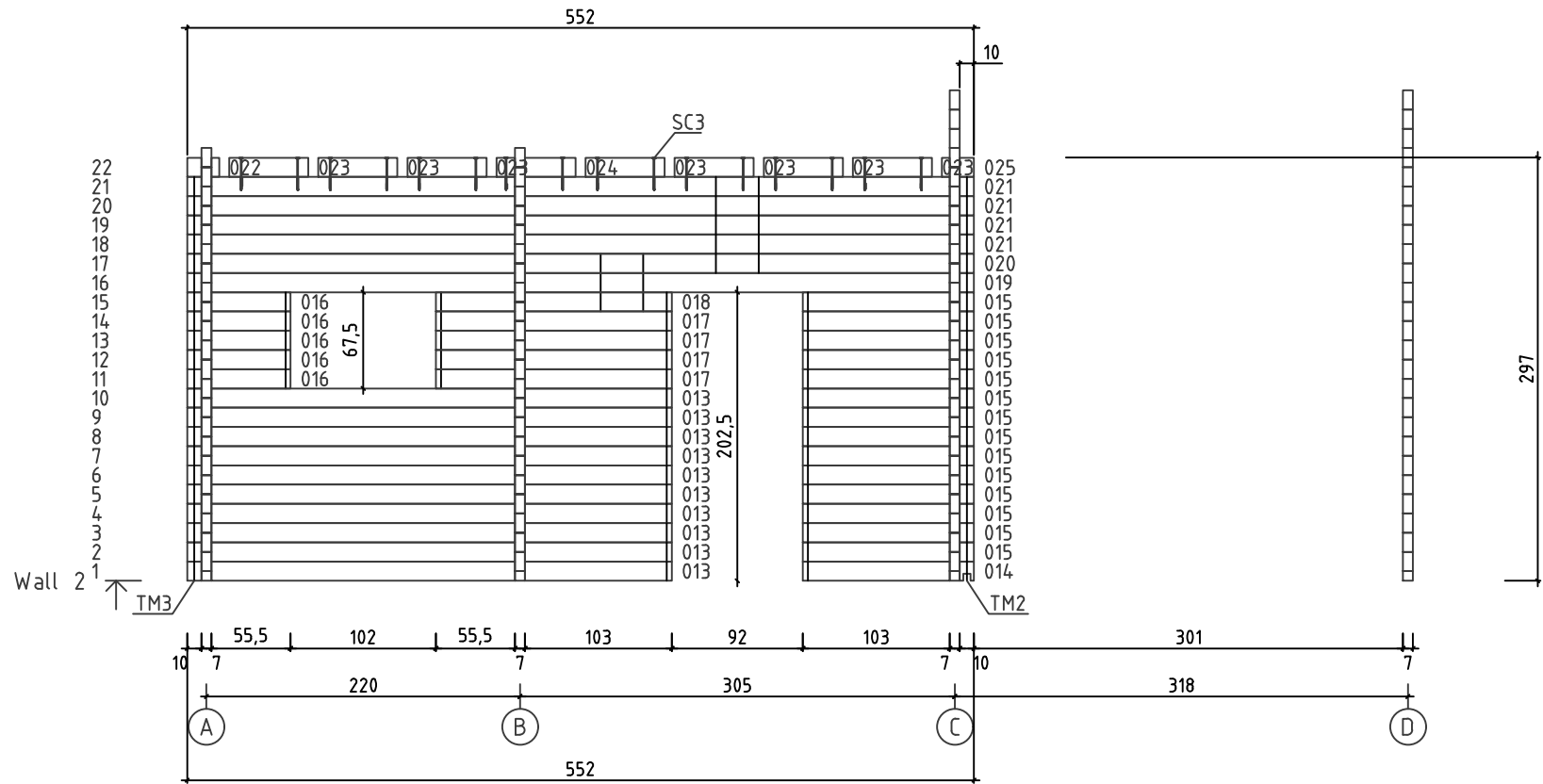

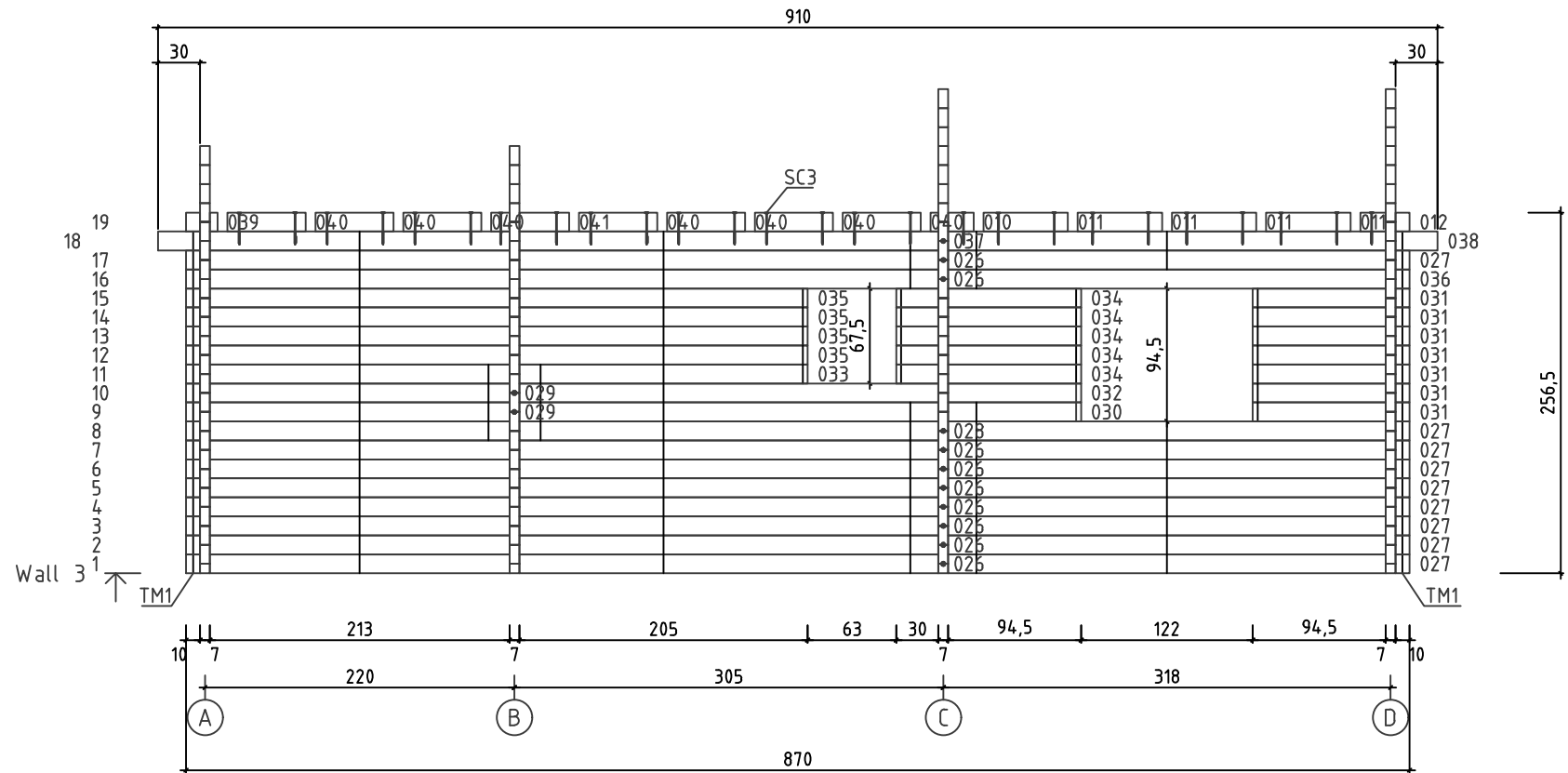

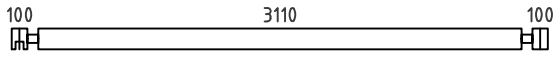
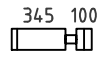
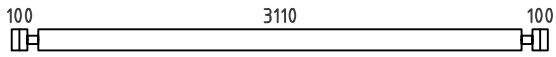
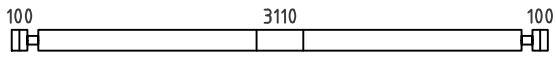
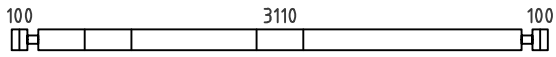
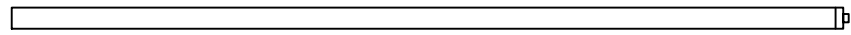
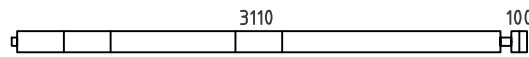
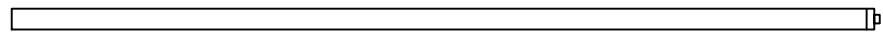
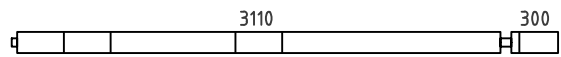
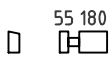
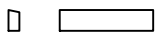
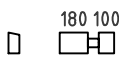
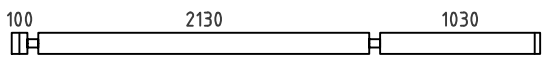
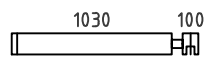
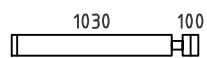
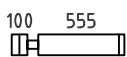

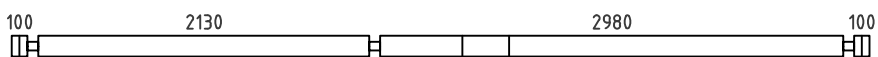
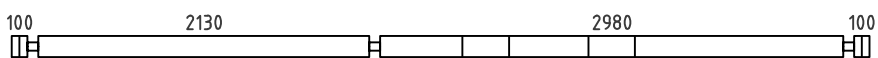
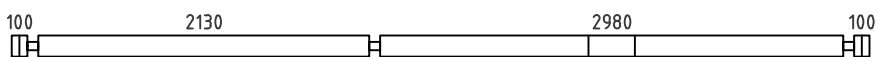
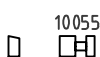
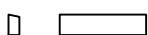
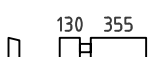



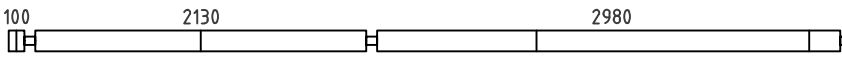
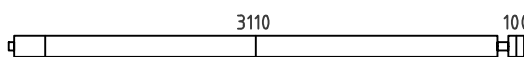
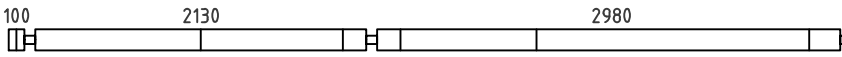
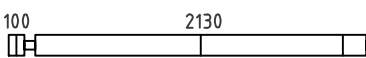
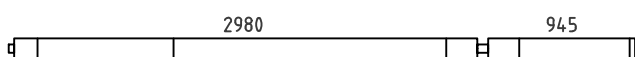
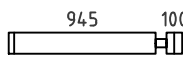
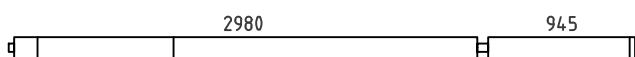

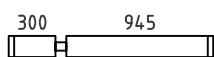
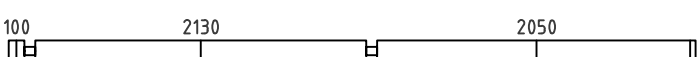
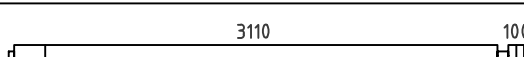
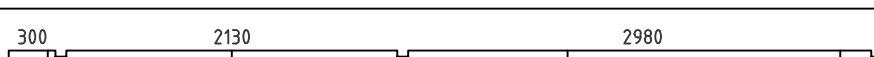
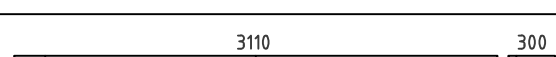
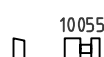
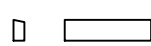
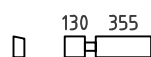
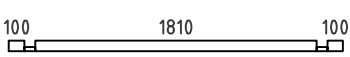
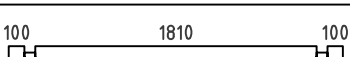
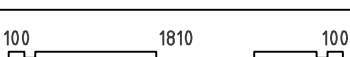
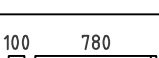
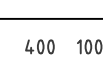
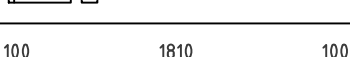

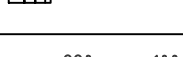



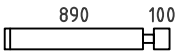
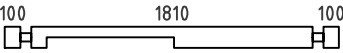
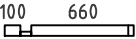

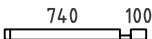
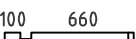

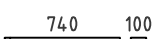
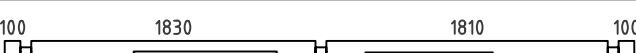
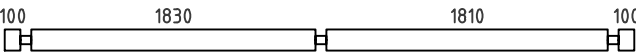
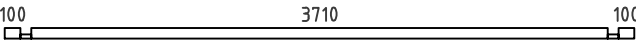
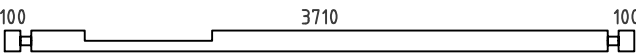

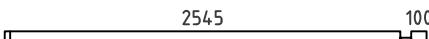
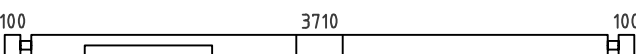
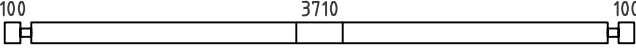
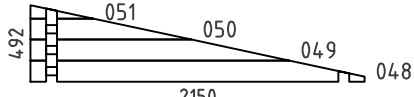
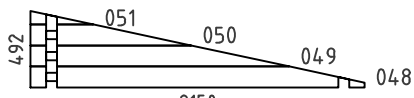
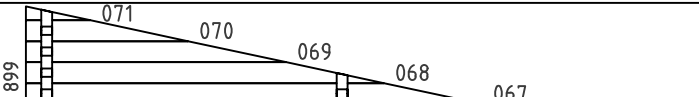
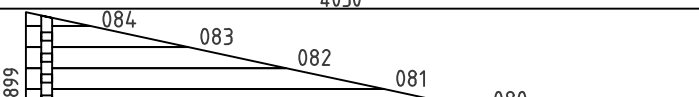
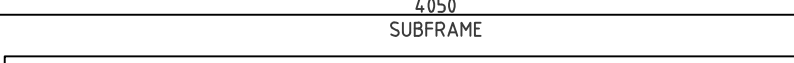

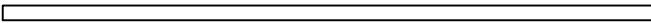
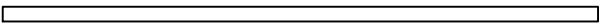
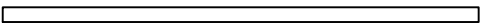
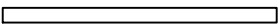

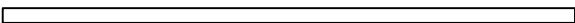
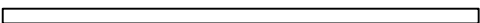
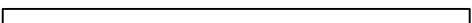
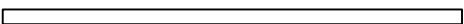

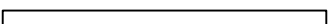
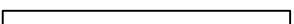

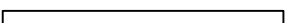
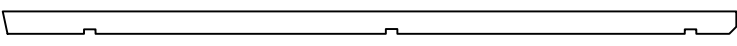
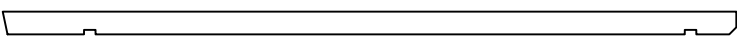
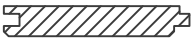
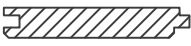
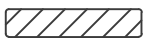
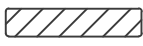
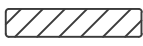
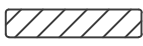
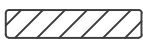
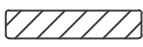



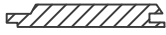

















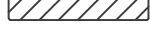

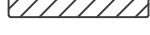
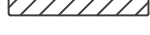
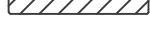
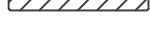

















Pos	Piece list	11/18	Q	P (mm)	L (mm)
001			1	70x135	3450
002			28	70x135	515
003			1	70x135	3450
004			5	70x135	3450
005			1	70x135	3450
006			1	70x135	5385
007			1	70x135	3315
008			1	70x135	5585
009			1	70x135	3515
010			2	70x135	305
011			8	70x135	600
012			2	70x135	350
013			10	70x135	3400
014			1	70x135	1200
015			14	70x135	1200
016			5	70x135	725
017			4	70x135	1655
018			1	70x135	1655
019			1	70x135	5520
020			1	70x135	5520
021			4	70x135	5520
022			1	70x133	225
023			7	70x133	555
024			1	70x133	555
025			1	70x133	225











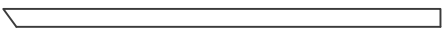





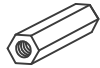

Pos	Piece list	12/18	Q	P (mm)	L (mm)
026			9	70x135	5385
027			9	70x135	3315
028			1	70x135	5385
029			2	70x135	2335
030			1	70x135	4030
031			7	70x135	1115
032			1	70x135	4030
033			1	70x135	4420
034			5	70x135	1315
035			4	70x135	4420
036			1	70x135	3315
037			1	70x135	5585
038			1	70x135	3515
039			1	70x135	225
040			7	70x135	555
041			1	70x135	555
042			1	70x68	2150
043			16	70x135	2150
044			1	70x135	2150
045			4	70x135	950
046			4	70x135	570
047			1	70x135	2150
052			1	70x68	270
053			1	70x68	1060
054			13	70x135	270







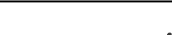

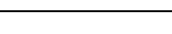
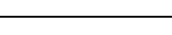



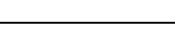

Pos	Piece list	13/18	Q	P (mm)	L (mm)
055			13	70x135	1060
056			1	70x135	2150
057			1	70x68	830
058			1	70x68	570
059			1	70x68	910
060			14	70x135	830
061			14	70x135	570
062			14	70x135	910
063			1	70x135	4050
064			3	70x135	4050
072			1	70x68	4050
073			1	70x135	4050
074			13	70x135	515
075			13	70x135	2715
076			1	70x135	4050
077			3	70x135	4050
WA-1			1		
WB-1			1		
WC-1			1		
WD-1			1		
IAR10			2	95x95	5133

Pos	Piece list	14/18	Q	P (mm)	L (mm)
IAR1	SUBFRAME 		1	95x95	4180
IAR6	SUBFRAME 		2	95x95	3830
IAR11	SUBFRAME 		2	95x95	3063
IAR3	SUBFRAME 		1	95x95	1763
IAR16	SUBFRAME 		1	45x95	5290
IAR4	SUBFRAME 		1	45x95	3728
IAR5	SUBFRAME 		4	45x95	3683
IAR14	SUBFRAME 		6	45x95	3063
IAR15	SUBFRAME 		1	45x95	3005
IAR13	SUBFRAME 		3	45x95	2955
IAR2	SUBFRAME 		5	45x95	2183
IAR12	SUBFRAME 		3	45x95	2083
IAR9	SUBFRAME 		1	45x95	1850
IAR7	SUBFRAME 		4	45x95	1805
IAR8	SUBFRAME 		1	45x95	1805
SR1	RAFTER 		9	70x145	4719
SR2	RAFTER 		5	70x145	4719
	FLOOR BOARDS 		28	112x28	3700
	FLOOR BOARDS 		47	112x28	1800
	TERRACE BOARDS 		12	120x28	5400
	TERRACE BOARDS 		15	120x28	5245
	TERRACE BOARDS 		2	120x28	4883
	TERRACE BOARDS 		1	120x28	4283
	TERRACE BOARDS 		1	120x28	4218
	TERRACE BOARDS 		2	120x28	3618

Pos	Piece list	15/18	Q	P (mm)	L (mm)
	ROOF BOARDS		27	90x18	4890
	ROOF BOARDS		26	90x18	4835
	ROOF BOARDS		26	90x18	4265
	ROOF BOARDS		27	90x18	4210
	FLOOR FILLET			13x40	28.06
KV1	FILLET FOR TERRACE RAILING		50	34x45	1665
KV2	FILLET FOR TERRACE RAILING		4	34x20	2200
TM1	TREADED ROD		2		2470
TM2	TREADED ROD		1		2810
TM3	TREADED ROD		1		2870
TM4	TREADED ROD		1		3220
TM5	TREADED ROD		1		3280
	DOOR/WINDOW COVERING MOULDING		4	18x95	610
	DOOR/WINDOW COVERING MOULDING		12	18x95	790
	DOOR/WINDOW COVERING MOULDING		2	18x95	800
	DOOR/WINDOW COVERING MOULDING		4	18x95	970
	DOOR/WINDOW COVERING MOULDING		2	18x95	1000
	DOOR/WINDOW COVERING MOULDING		4	18x95	1060
	DOOR/WINDOW COVERING MOULDING		6	18x95	1160
	DOOR/WINDOW COVERING MOULDING		2	18x95	1200
	DOOR/WINDOW COVERING MOULDING		4	18x95	1260
	DOOR/WINDOW COVERING MOULDING		2	18x95	1360
	DOOR/WINDOW COVERING MOULDING		2	18x95	1560
	DOOR/WINDOW COVERING MOULDING		4	18x95	1850
	DOOR/WINDOW COVERING MOULDING		12	18x95	1970

Pos	Piece list	16/18	Q	P (mm)	L (mm)
	DOOR/WINDOW COVERING MOULDING		8	18x95	2015
	DOOR/WINDOW COVERING MOULDING		2	18x95	2400
	DOOR/WINDOW COVERING MOULDING		2	18x95	2760
	POST		1	95x95	2930
	SIDE ROOF EDGE REINFORCEMENT		2	34x45	4700
	HIDDEN FIXING		1	15x15	250
	HIDDEN FIXING		6	15x15	350
	HIDDEN FIXING		2	15x15	480
	HIDDEN FIXING		2	15x15	610
	HIDDEN FIXING		2	15x15	913
	HIDDEN FIXING		4	15x15	1012
	HIDDEN FIXING		2	15x15	1150
	HIDDEN FIXING		2	15x15	2360
	FIXING FILLET OF DOOR/WINDOW		2	34x45	475
	FIXING FILLET OF DOOR/WINDOW		4	34x45	610
	FIXING FILLET OF DOOR/WINDOW		2	34x45	878
	FIXING FILLET OF DOOR/WINDOW		2	34x45	1688
	FIXING FILLET OF DOOR/WINDOW		2	34x45	1755
	FIXING FILLET OF DOOR/WINDOW		2	34x45	1822
	FIXING FILLET OF DOOR/WINDOW		4	34x45	1890
	FIXING FILLET OF DOOR/WINDOW		2	34x45	1958
GMC	GABLE CONNECTING PROFILE		2	18x95	180
GM1	FRONTSIDE GABLE BASE PROFILE		2	18x95	4586
GM2	FRONTSIDE GABLE MOULDING		4	18x120	4586
GM3	BACKSIDE GABLE BASE PROFILE		2	18x95	4550

Pos	Piece list	17/18	Q	P (mm)	L (mm)
GM4	BACKSIDE GABLE MOULDING		4	18x120	4550
GM5	LEFT/RIGHT SIDE GABLE BASE PROFILE		2	18x95	4800
GM6	LEFT/RIGHT SIDE GABLE MOULDING		2	18x120	4780
GM7	LEFT/RIGHT SIDE GABLE MOULDING		2	18x120	4800
KV3	FILLET FOR TERRACE RAILING		2	18x95	2200
	NAIL FOR SUBFRAME METAL CORNER		160		
	NAIL FOR JOINING WALL LOGS PLATE		60		
	SHINGLE UNDERLAY			45 m ²	
	ROOF SHINGLES			45 m ²	
	ROOF SHINGLE EDGE PROFILE				
	LENGTHENING BOLT FOR TREADED ROD		6		
	DRIVE NUT TREADED ROD		6		
	NUT TREADED ROD		6		
	NUT TREADED ROD		6		
	SCREW FOR FLOOR BOARD		633	4.9x42	
	SCREW FOR METAL CORNER		136	4x40	
	SCREW FOR DOOR/WINDOW COVERING MOULDING		394	4x40	
	SCREW FOR ROOF EDGE REINFORCEMENT		40	4x40	
	SCREW FOR METAL CORNER FOR TERRACE RAILING		15	4x40	
	SCREW FOR GABLE MOULDING		276	4x40	
	SCREW FOR TERRACE RAILING		160	4x40	
	SCREW FOR FIXING FILLET OF DOOR/WINDOW		132	4x60	
	SCREW FOR SUBFRAME		20	5x90	
	SCREW FOR POST		6	5x90	
	SCREW FOR SUBFRAME		60	6x140	

Pos	Piece list	18/18	Q	P (mm)	L (mm)
	SCREW FOR FIRST ROW		17	6x140	
	SCREW FOR RAFTER		30	6x140	
	SCREW FOR FIRST ROW		14	6x180	
SC3	SCREW FOR WALL DETAIL		62	6x180	
SC4	SCREW FOR WALL DETAIL		11	6x220	
	SCREW FOR POST HEIGHT ADJUSTMENT		8	6x50	
	SCREW FOR TERRACE BOARD		720	4x60	
	HAMMER BLOCK		2		
	NAIL FOR ROOF BOARD		1519	2.5x60	
	NAIL FOR SHINGLE		1575		
	NAIL FOR FLOOR FILLET		70		
	PLATE FOR JOINING WALL LOGS		15		
	METAL CORNER FOR SUBFRAME		20	40x40x40	
MCR	METAL CORNER RAFTER		17	40x40x40	
MC	METAL CORNER FOR TERRACE RAILING		3	35x35x130	
PHR	POST HEIGHT ADJUSTMENT		1		
DW.0	WINDOW 2400x1835		1		
DW.0	WINDOW 800x1835		1		
DW.R	WINDOW 1200x880		1		
SW.L	WINDOW 1000x610		1		
SW.L	WINDOW 610x610		2		
SAUN A.D.L	DOOR 800x1850		1		
SD.R	DOOR 900x1970		2		
SD.R	DOOR 800x1970		1		