

Carport
1/9

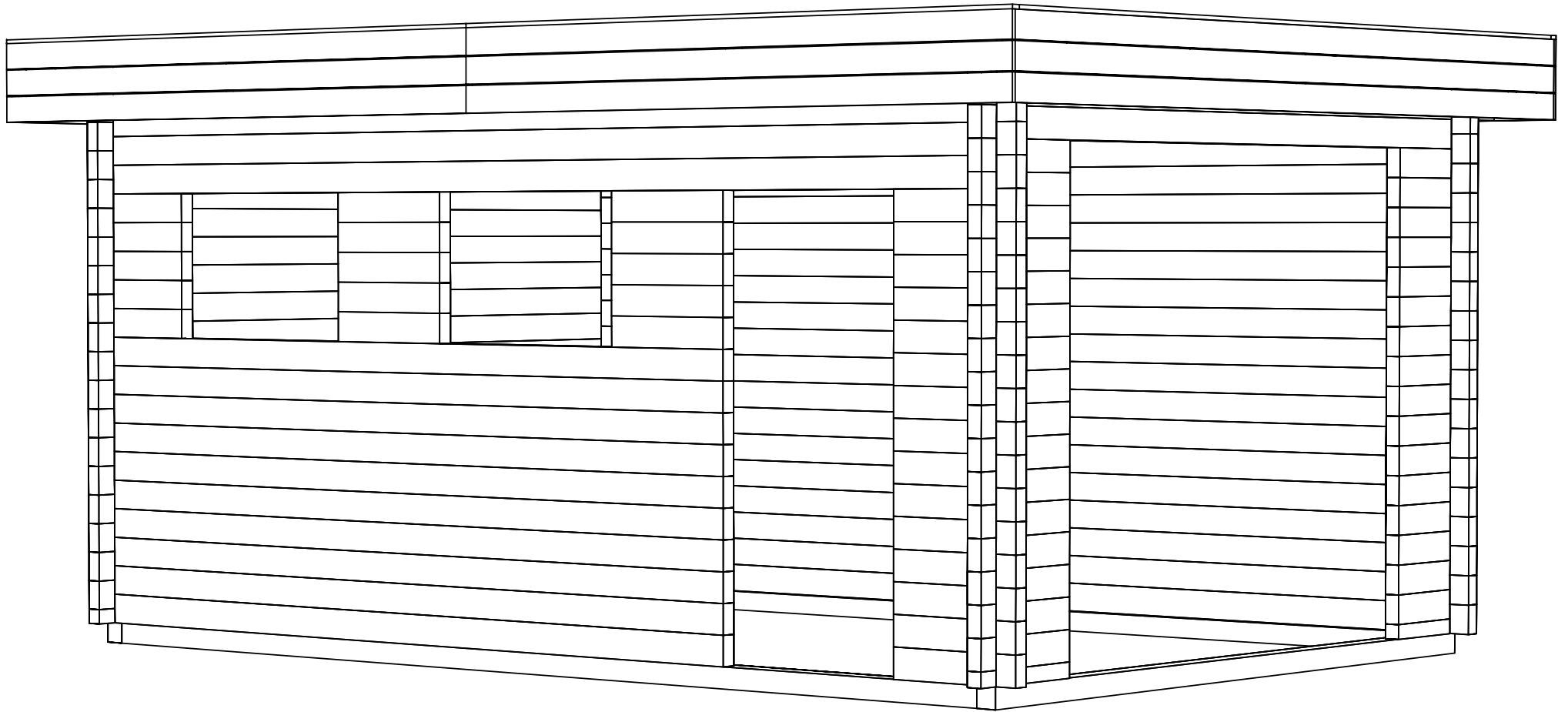

GROUND PLAN

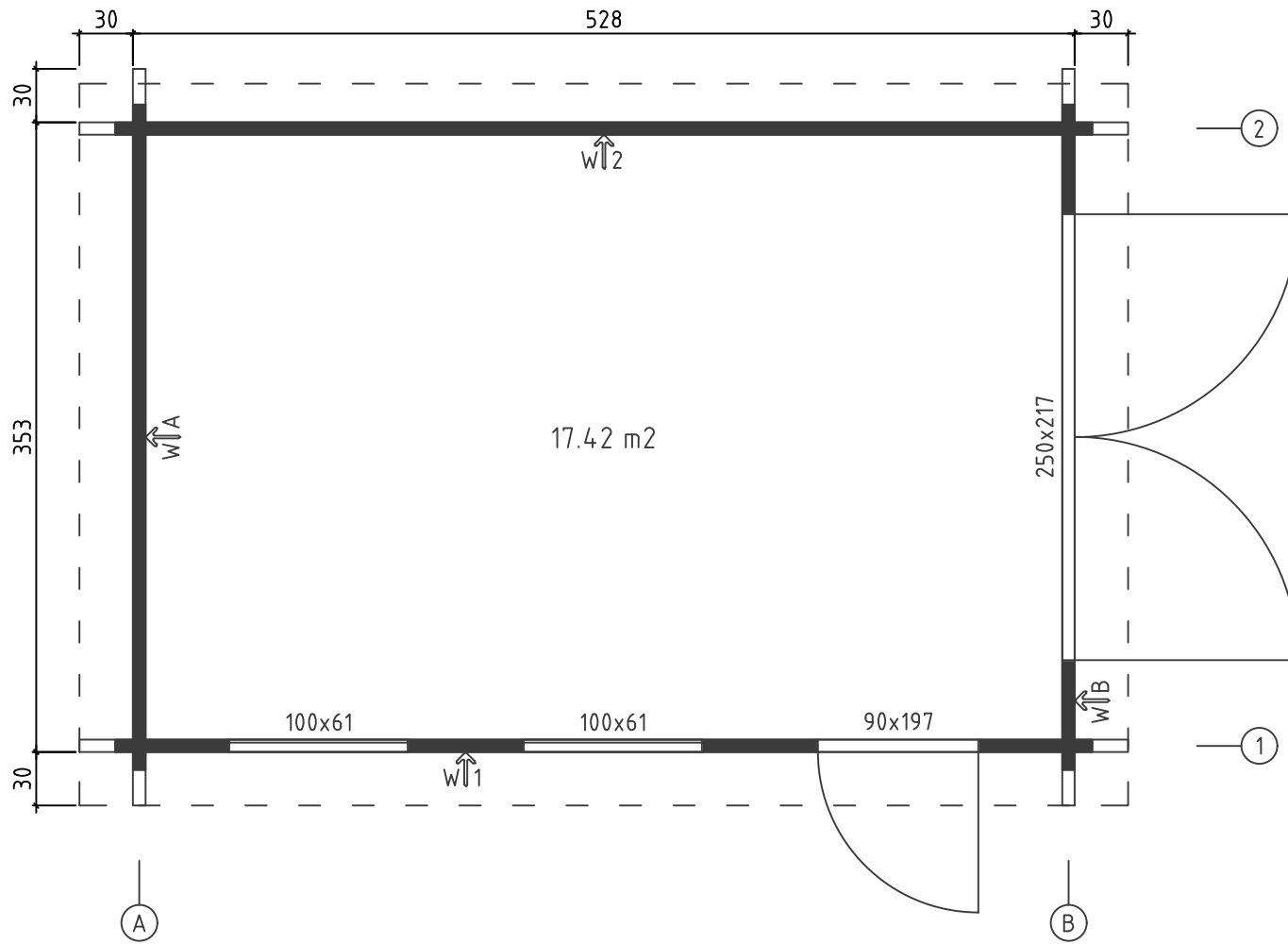

SUBFRAME PLAN

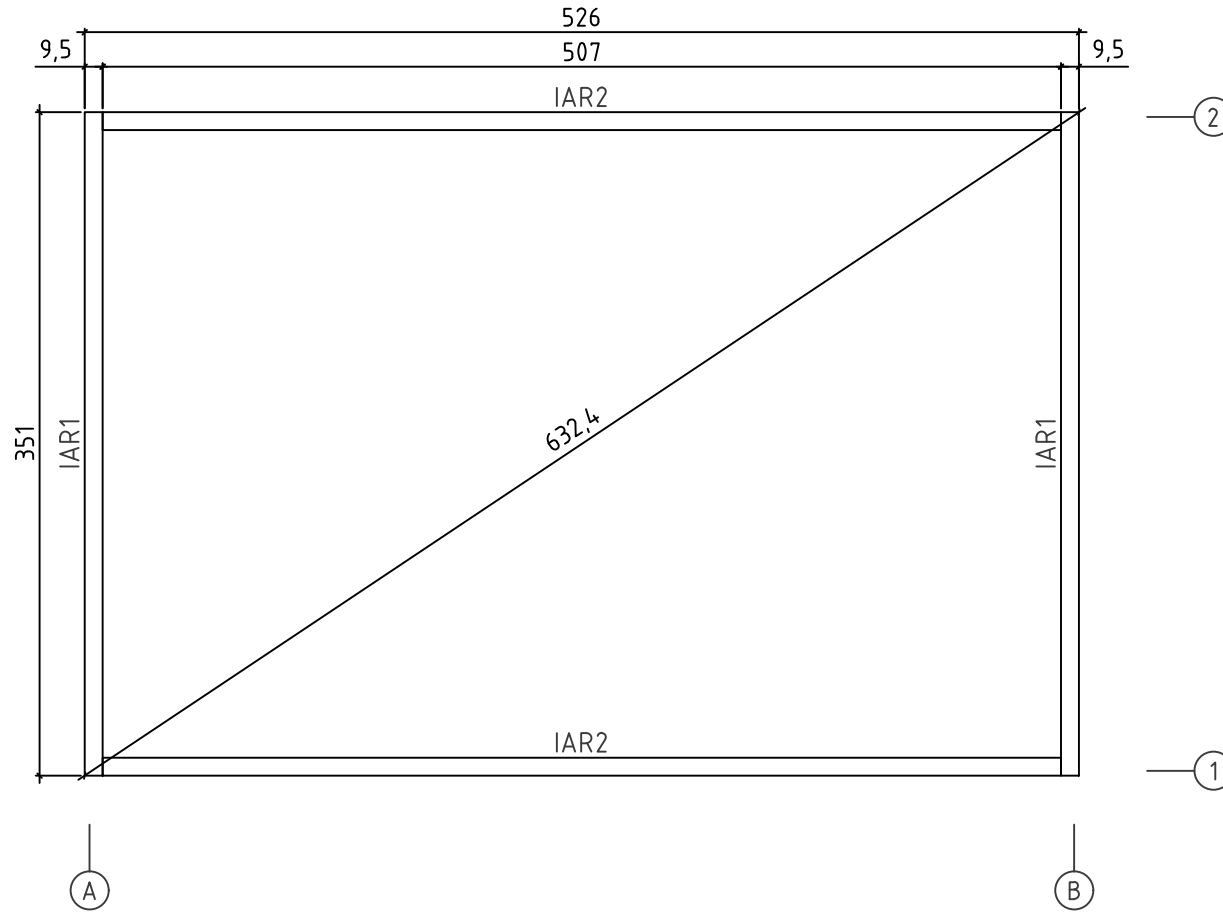



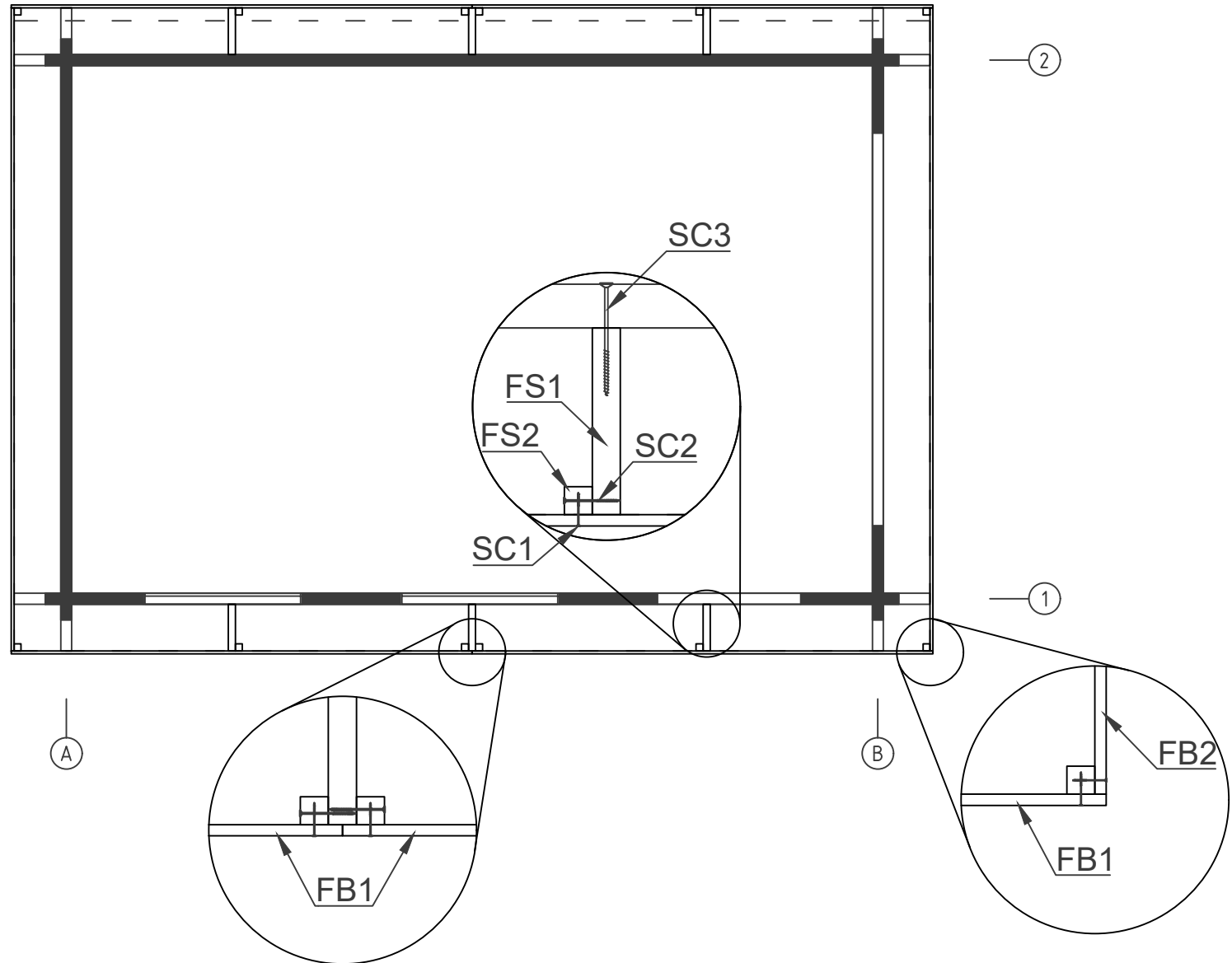

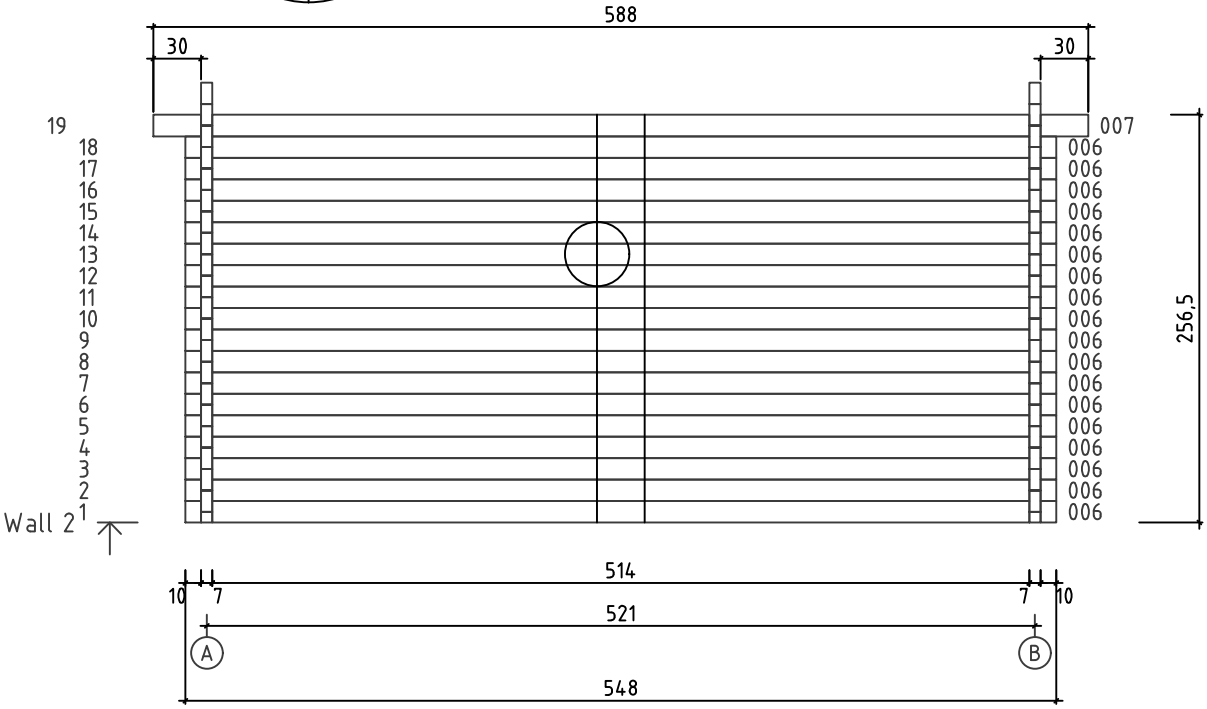
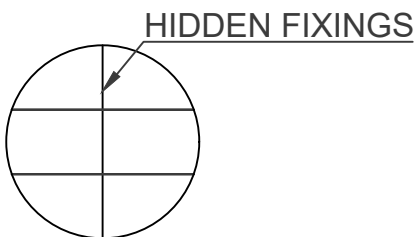
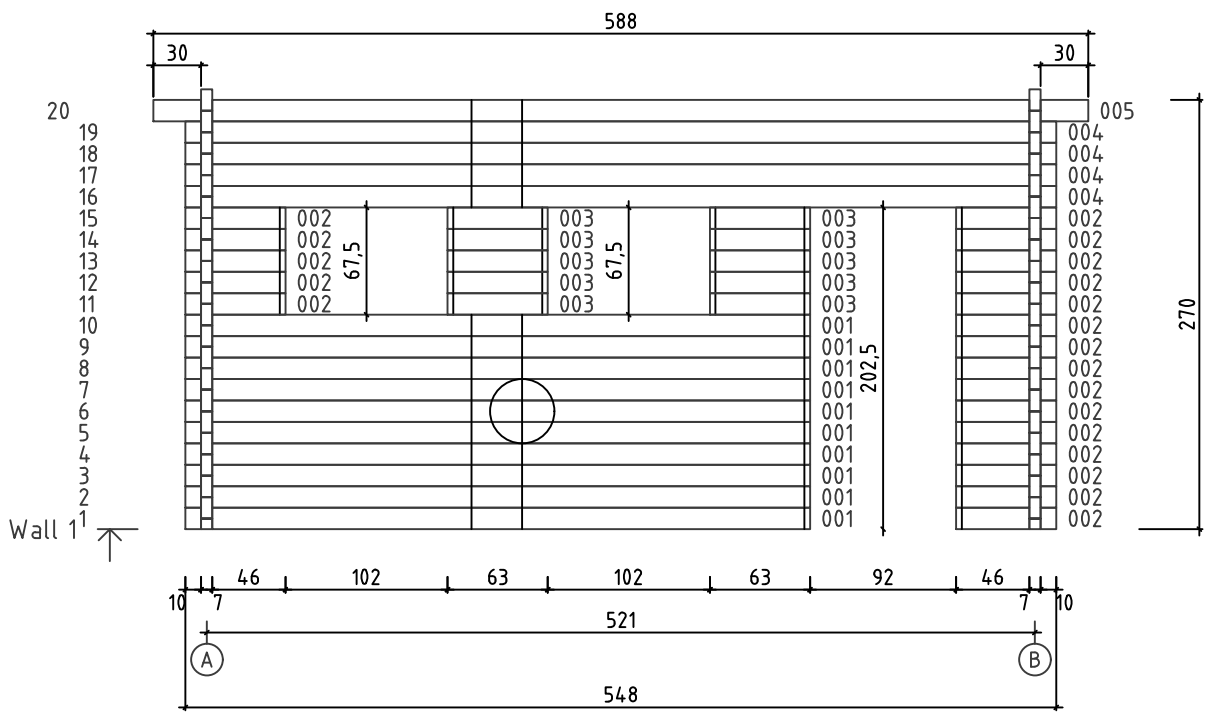

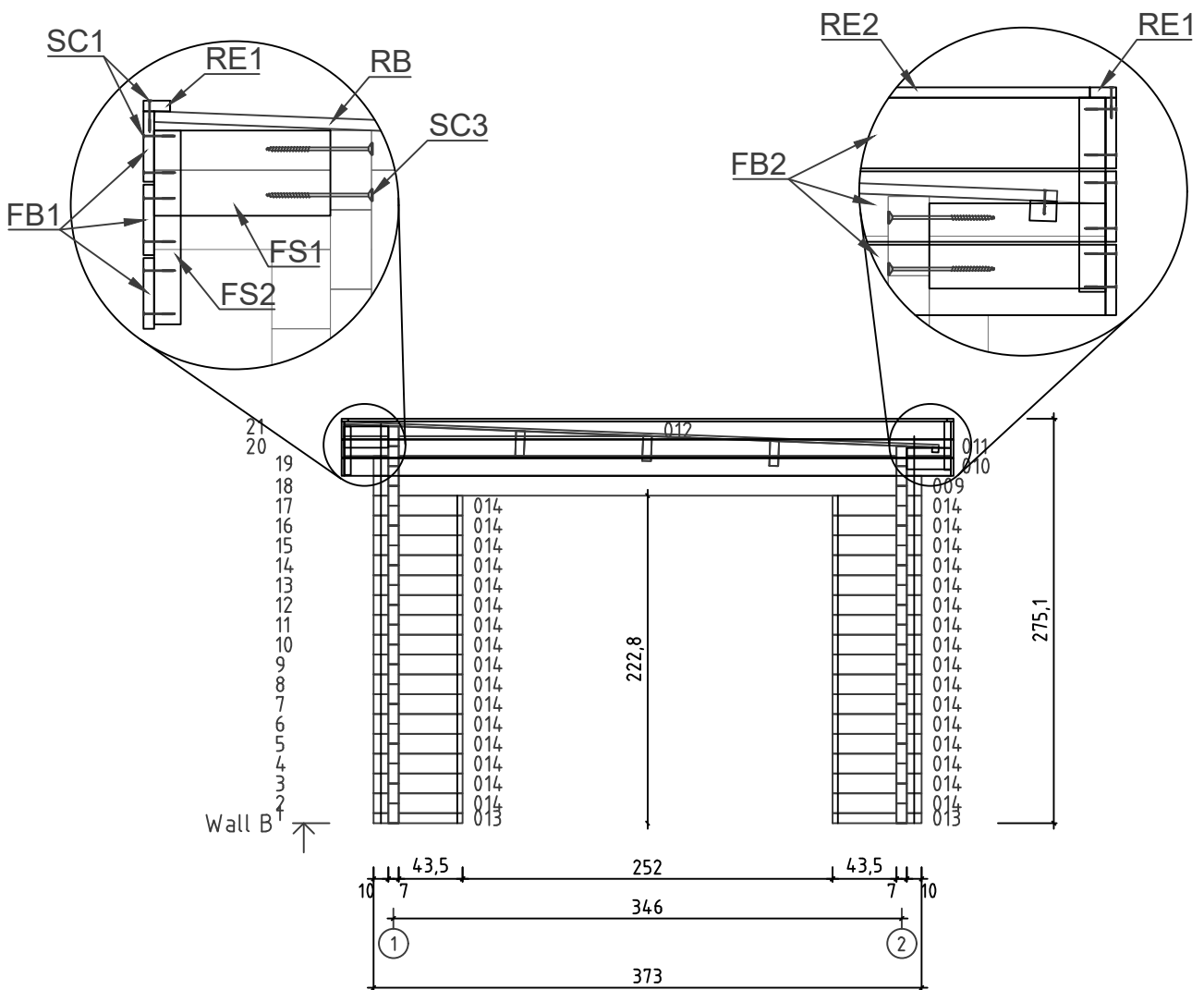
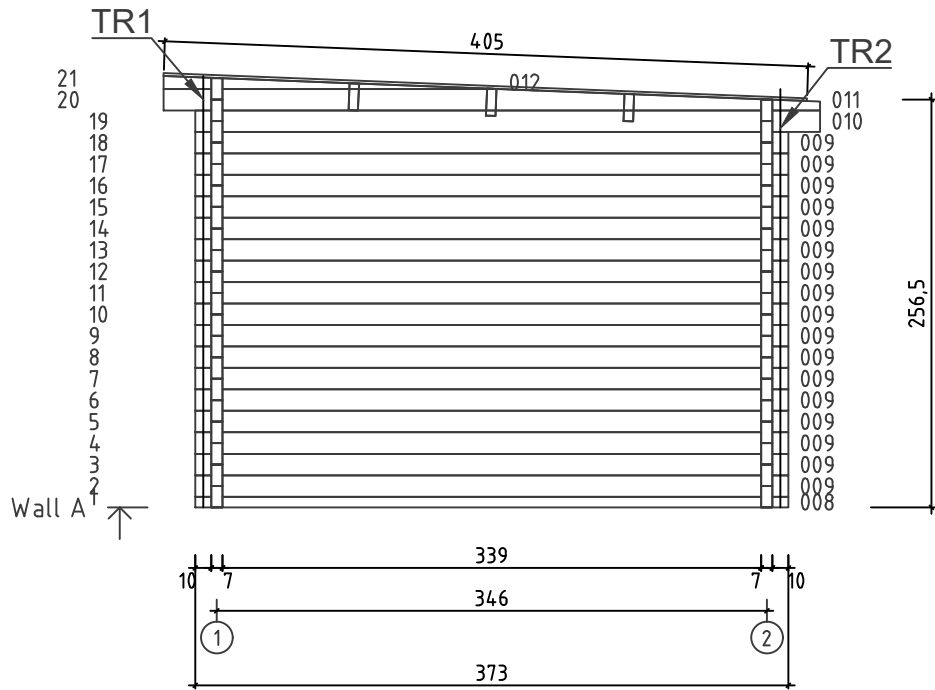

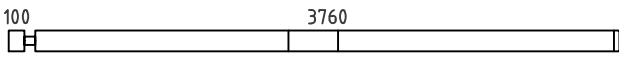
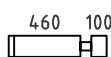
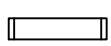
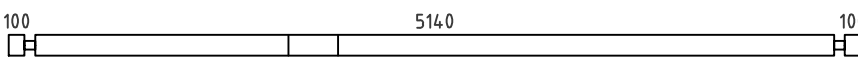
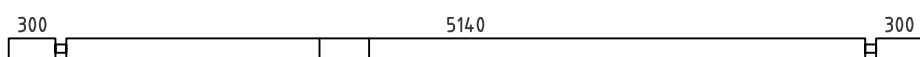
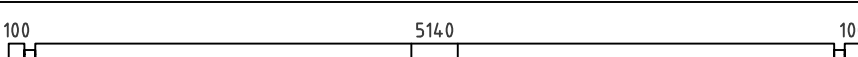
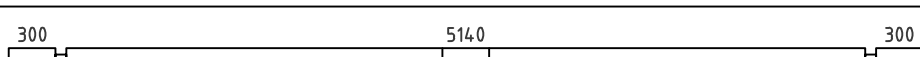
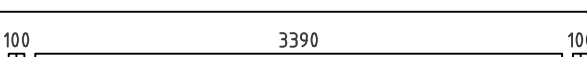
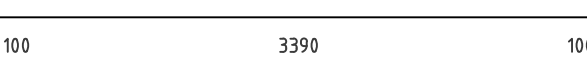
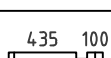
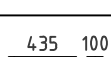
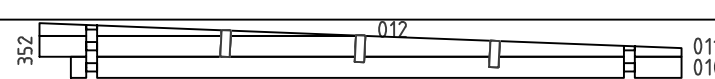
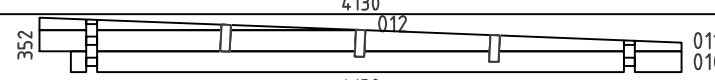
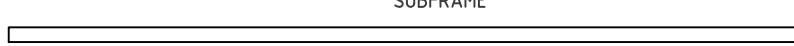





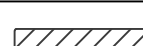
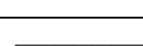
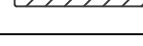
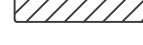















ROOF PLAN







Pos	Piece list	7/9	Q	P (mm)	L (mm)
001			10	70x135	3930
002			20	70x135	630
003			10	70x135	630
004			4	70x135	5480
005			1	70x135	5880
006			18	70x135	5480
007			1	70x135	5880
008			1	70x68	3730
009			18	70x135	3730
013			2	70x68	605
014			32	70x135	605
WA-1			1		
WB-1			1		
IAR2	SUBFRAME 		2	95x95	5070
IAR1	SUBFRAME 		2	95x95	3510
A-PR1	ROOF BEAM 5140 		3	70x190	5880
RB	ROOF BOARDS 		66	90x18	4050
RE1	ROOFING FELT FILLET		4	18x45	2958
RE2	ROOFING FELT FILLET		2	18x45	4076
TR2	TREADED ROD 		2		2600
TR1	TREADED ROD 		2		2745
	DOOR/WINDOW COVERING MOULDING 		8	18x95	790
	DOOR/WINDOW COVERING MOULDING 		4	18x95	1000
	DOOR/WINDOW COVERING MOULDING 		2	18x95	1260
	DOOR/WINDOW COVERING MOULDING 		4	18x95	1360

Pos	Piece list	8/9	Q	P (mm)	L (mm)
	DOOR/WINDOW COVERING MOULDING		4	18x95	1970
	DOOR/WINDOW COVERING MOULDING		4	18x95	2170
	DOOR/WINDOW COVERING MOULDING		2	18x95	2860
	ROOFING FELT		5		6080
RT	ROOF EDGE REINFORCEMENT		2	34x45	300
RT	ROOF EDGE REINFORCEMENT		2	34x45	2570
	HIDDEN FIXING		2	15x15	620
	HIDDEN FIXING		2	15x15	1300
	HIDDEN FIXING		2	15x15	2490
	FIXING FILLET OF DOOR/WINDOW		4	34x45	620
	FIXING FILLET OF DOOR/WINDOW		2	34x45	1958
	FIXING FILLET OF DOOR/WINDOW		2	34x45	2160
FS2	FASCIA BOARD SUPPORT		12	45x45	330
FS1	FASCIA BOARD SUPPORT		6	45x145	300
FB1	FASCIA BOARD		12	18x120	2958
FB2	FASCIA BOARD		6	18x120	4130
	NAIL FOR SUBFRAME METAL CORNER		48		
	LENGTHENING BOLT FOR TREADED ROD		4		
	DRIVE NUT TREADED ROD		4		
	NUT TREADED ROD		4		
	PLAIN WASHER TREADED ROD		4		
SC1	SCREW FOR ROOFING FELT FILLET		40	4x40	
SC1	SCREW FOR DOOR/WINDOW COVERING MOULDING		152	4x40	
SC1	SCREW FOR ROOF EDGE REINFORCEMENT		20	4x40	
SC1	SCREW FOR FASCIA BOARD		124	4x40	

