

H = 1.500 m
 TOTAL: 8.46 m²

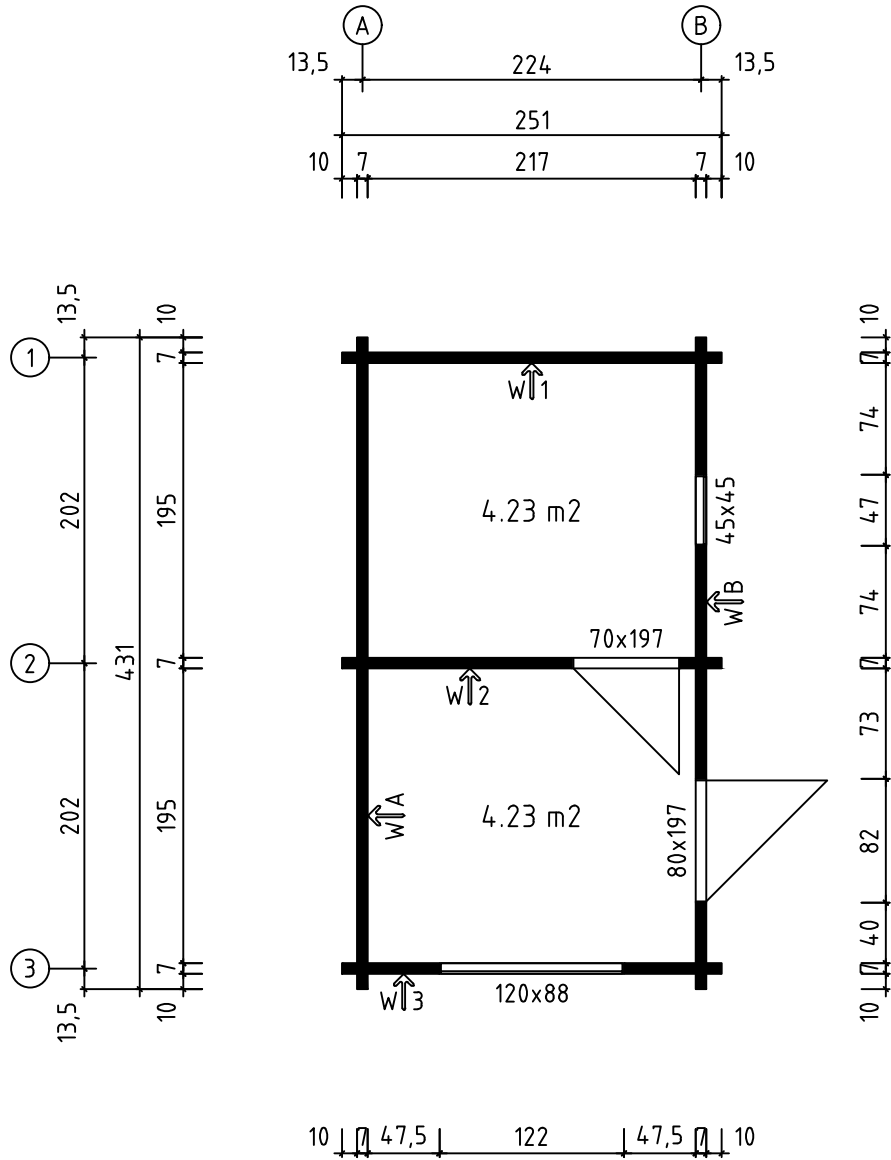

Code	Saun 2.7	Sheet	1
Drawing		Scale	1:50
Material	7x13.5	Date	04.04.2017
Drew	M.Mere	File	Saun 2.7.dwg

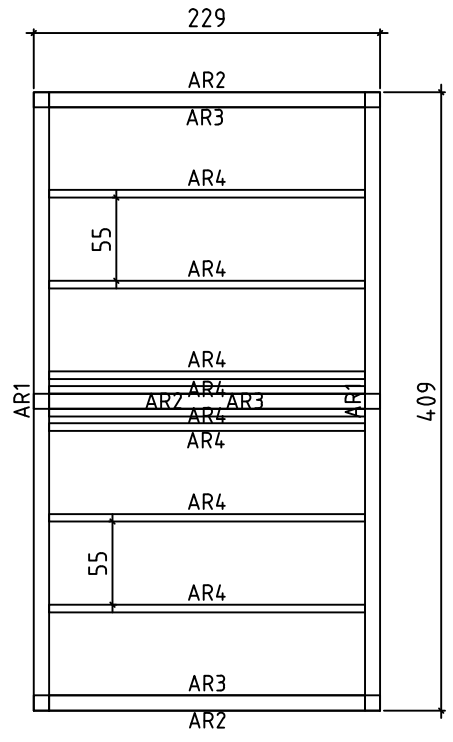
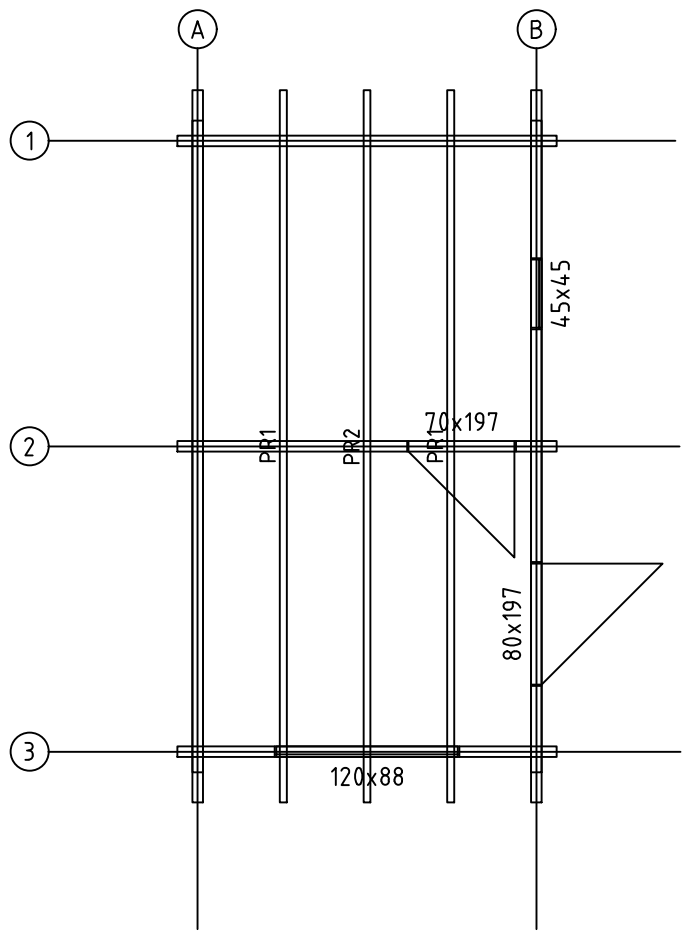

Code	Saun 2.7	Sheet	1
Drawing	Floorplan	Scale	1:50
Material	7x13.5	Date	04.04.2017
Drew	M.Mere	File	Saun 2.7.dwg

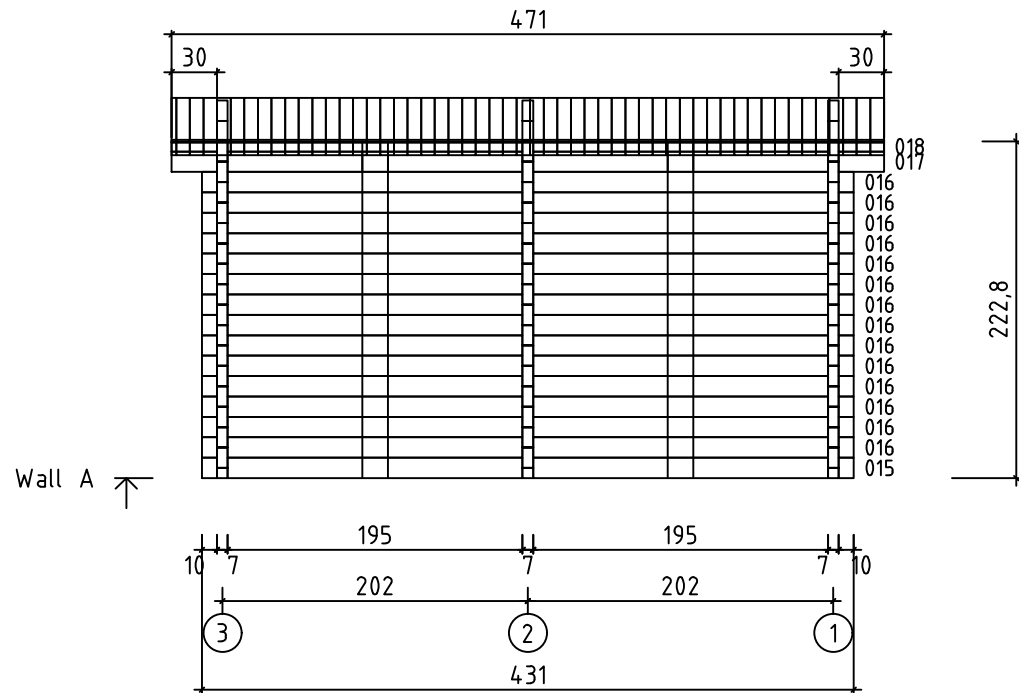

Code	Saun 2.7	Sheet	2
Drawing	WALL A	Scale	1:50
Material	7x13.5	Date	04.04.2017
Drew	M.Mere	File	Saun 2.7.dwg

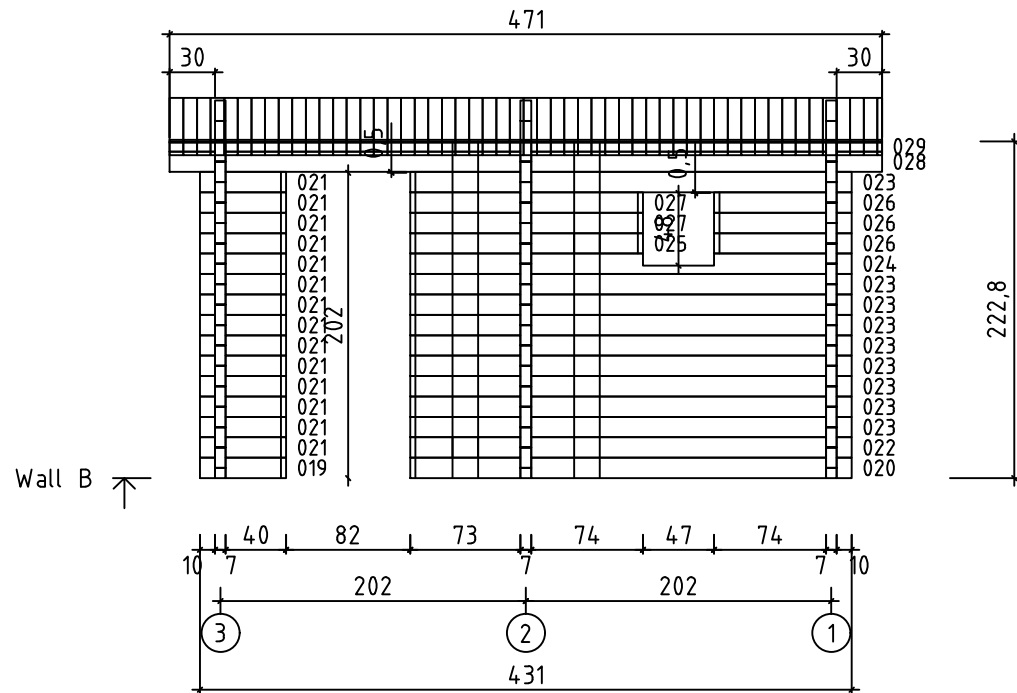

Code	Saun 2.7	Sheet	3
Drawing	WALL B	Scale	1:50
Material	7x13.5	Date	04.04.2017
Drew	M.Mere	File	Saun 2.7.dwg

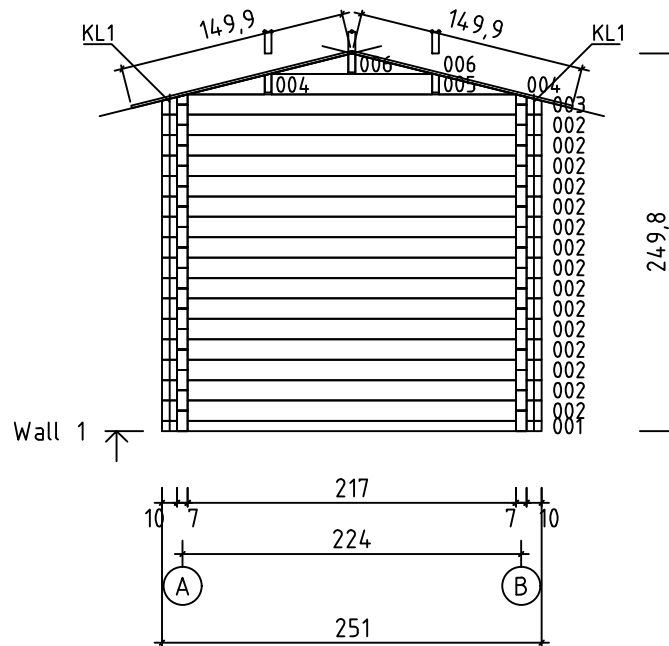

Code	Saun 2.7	Sheet	4
Drawing	WALL 1	Scale	1:50
Material	7x13.5	Date	04.04.2017
Drew	M.Mere	File	Saun 2.7.dwg

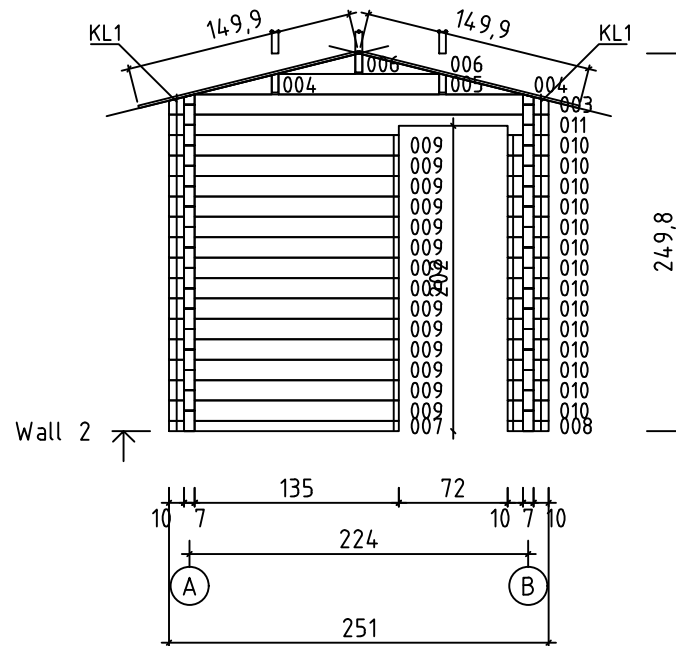

Code	Saun 2.7	Sheet	5
Drawing	WALL 2	Scale	1:50
Material	7x13.5	Date	04.04.2017
Drew	M.Mere	File	Saun 2.7.dwg

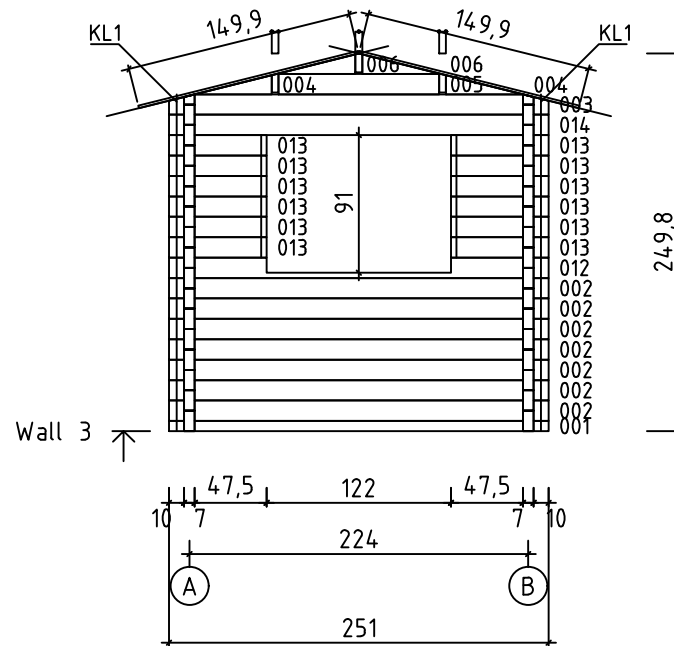

Code	Saun 2.7	Sheet	6
Drawing	WALL 3	Scale	1:50
Material	7x13.5	Date	04.04.2017
Drew	M.Mere	File	Saun 2.7.dwg

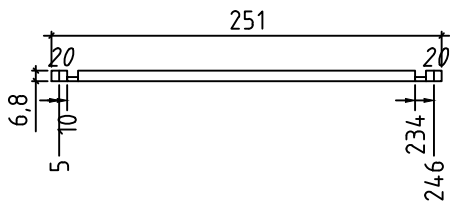

001 /2
Alumine poolik

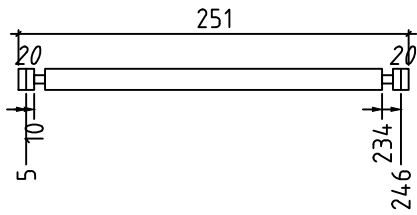

002 /22

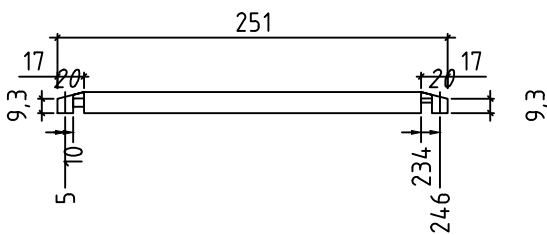

003 /3
Kalle

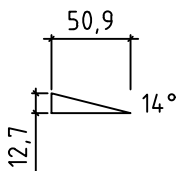

004 /6
5,6,7,8;Ülemine poolik

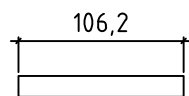

005 /3

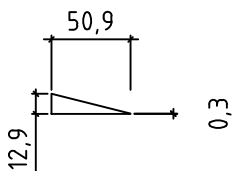

006 /6
Kalle;Ülemine poolik

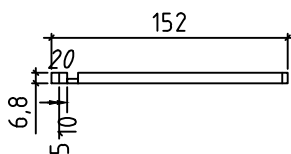

007 /1
Alumine poolik

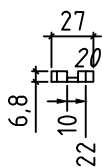

008 /1
Alumine poolik

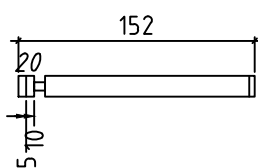

009 /14

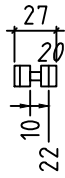

010 /14

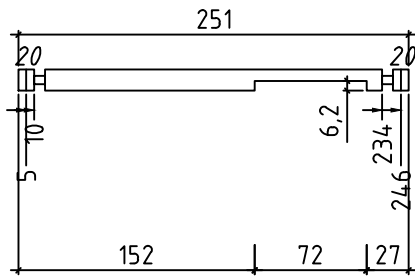
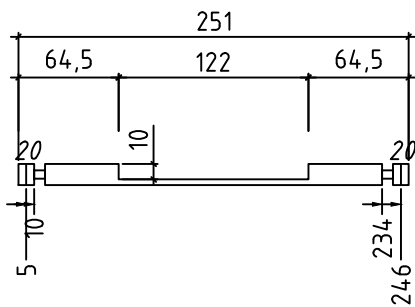
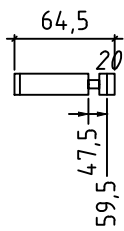
011 /1
Väljalõige012 /1
Väljalõige

013 /12

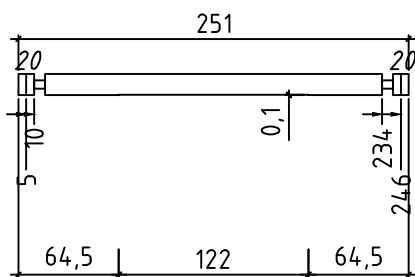
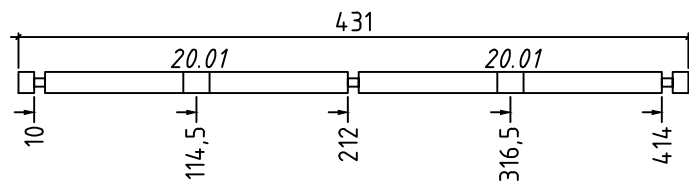
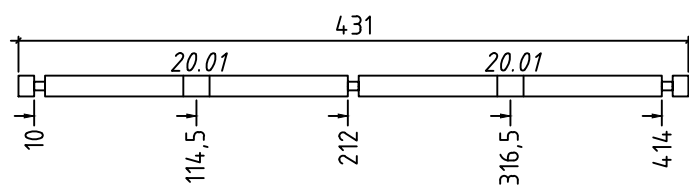
014 /1
Väljalõige015 /1
Alumine terve

016 /14

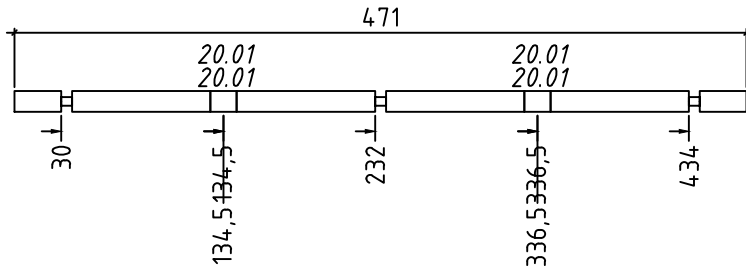

017 /1

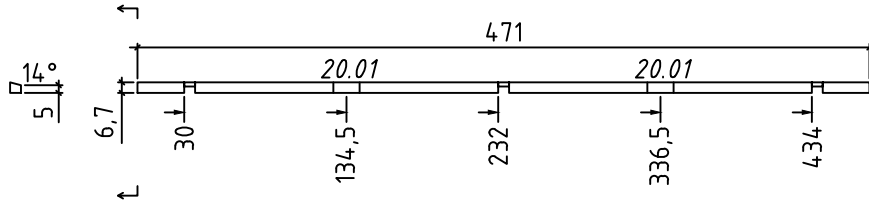

018 /1
Kalle

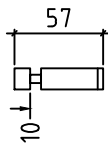

019 /1
Alumine terve

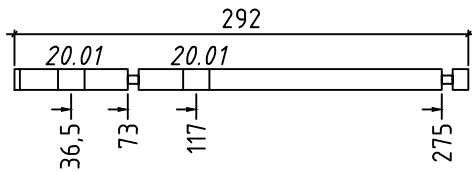

020 /1
Alumine terve

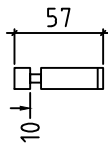

021 /14

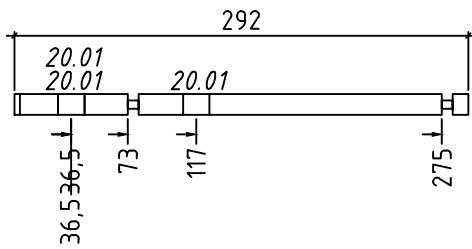

022 /1

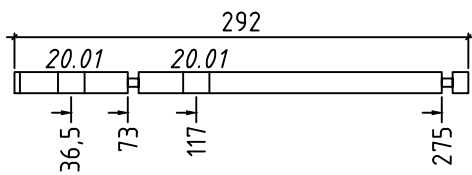

023 /9

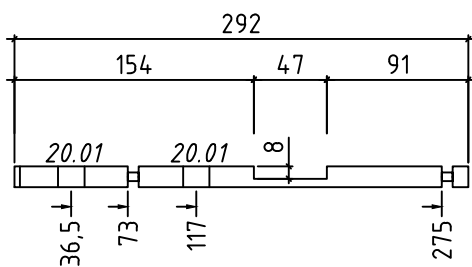

024 /1
Väljalõige

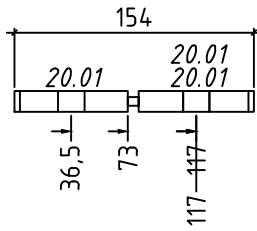

025 /1

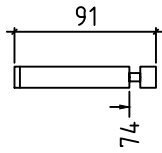

026 /3

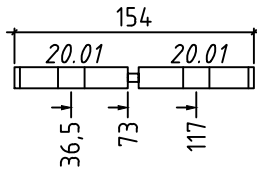

027 /2

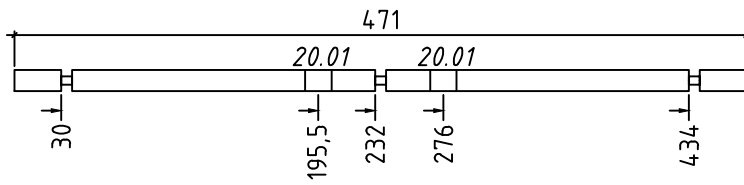

028 /1

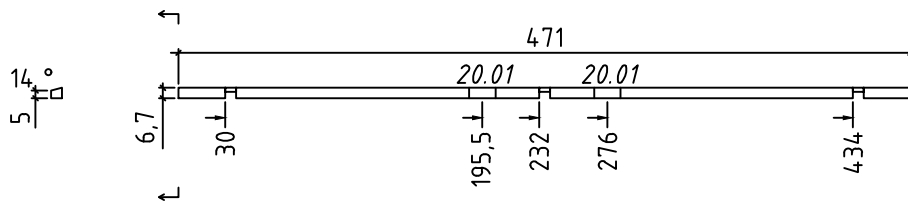
029 /1
Kalle

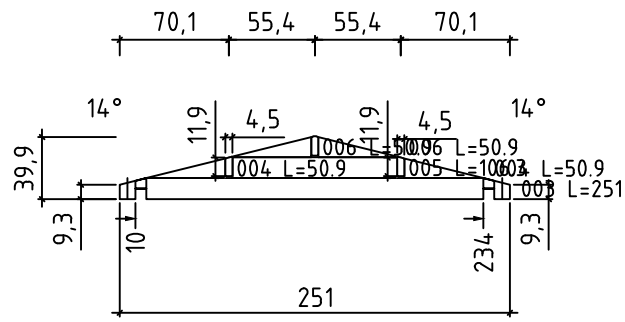

W1-1

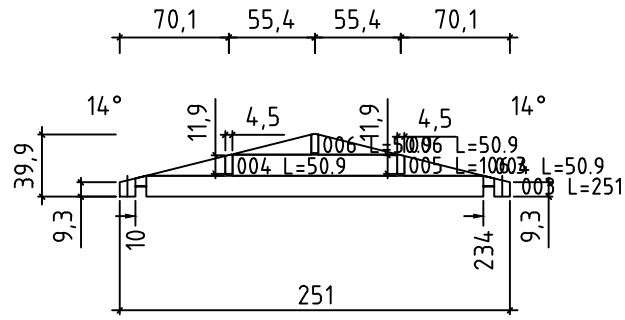

W2-1

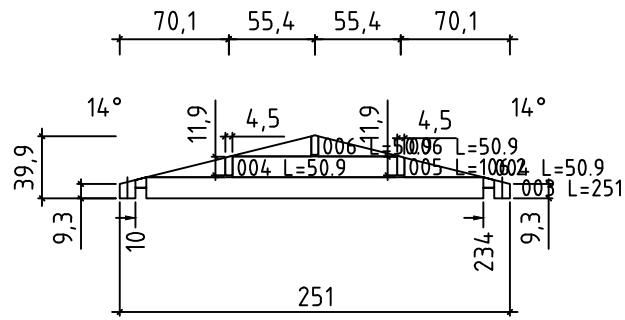

W3-1

ALUSRAAM-BASE FRAME

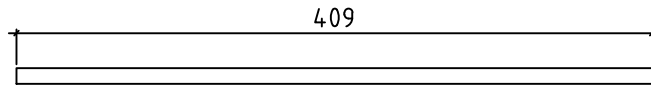

AR1 /2
10x10

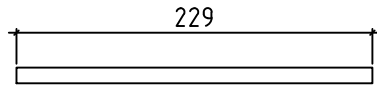

AR2 /3
10x10

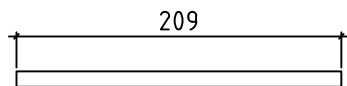

AR3 /3
10x10

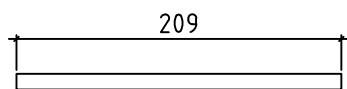

AR4 /8
5x10

PÕHIPÄRLINID-CEILING BEAMS

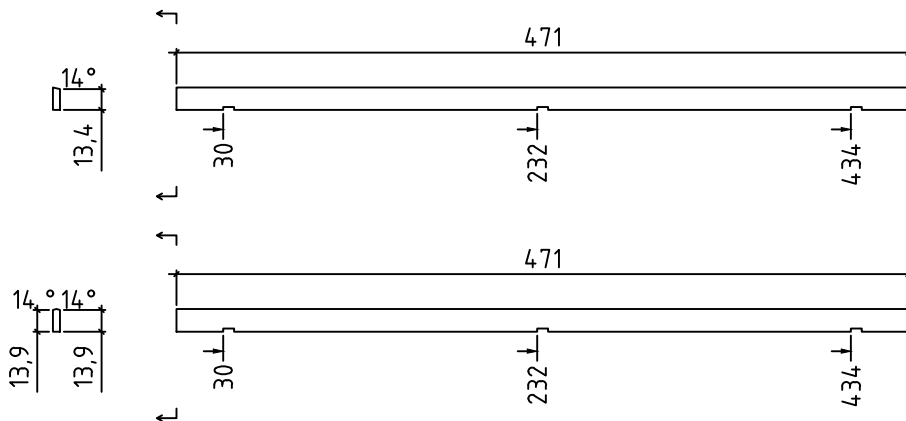

PR1 /2
4.5x14.5(4.5x12.5)

PR2 /1
4.5x14.5(4.5x12.5)

PÕRANDALAUD-FLOORBOARD TUUP1 11.2x2.8



194 cm

40 pcs.

KATUSELAUD-ROOFBOARD TUUP1 9x1.8

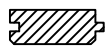

149.9 cm

106 pcs.

LIIST 2x4



16.4 r.m.

OTSALAUD-BOARDS FOR GABLE 2.1x14

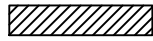

TOTAL
199.9 cm

8 r.m.
4 pcs.

RÄÄSTALAUD-BOARDS FOR EAVES 2.1x12

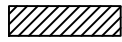

TOTAL
481 cm

9.62 r.m.
2 pcs.

RÄÄSTALIIST-SLAT FOR EAVES 4.5x4.5



TOTAL
491 cm

9.82 r.m.
2 pcs.

Salapulk 1.5x1.5



TOTAL
25 cm
18 cm









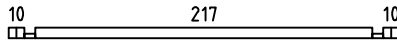
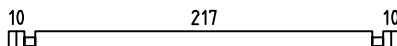
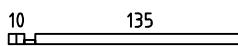

17.44 j.m.
64 pcs.
8 pcs.

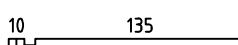

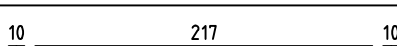
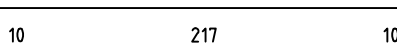
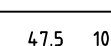
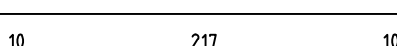
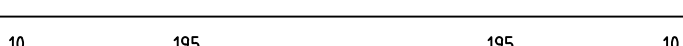
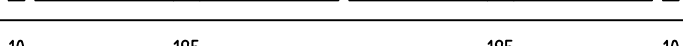
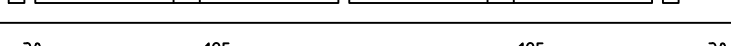

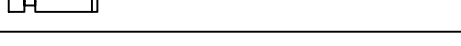

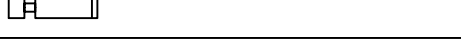
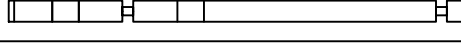
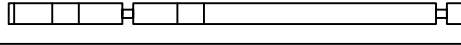
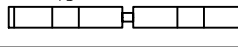
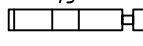
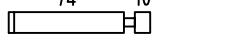

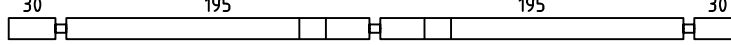
120x88 - 1 Set

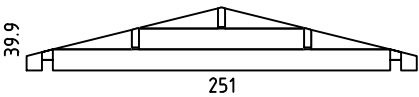
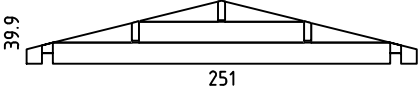
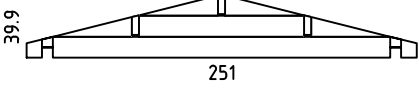
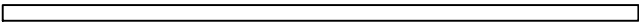
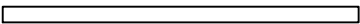
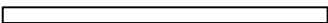
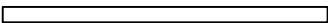
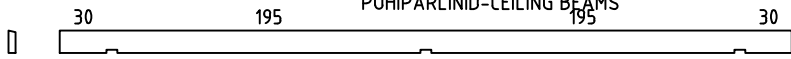
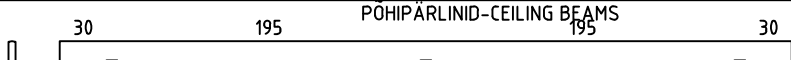
45x45 - 1 Set

70x197 - 1 Set

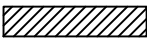
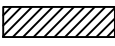
80x197 - 1 Set

Pos	Drawing Saun 2.7	Number	Profile (cm)	Length (cm)
001		2	7x6.8	251
002		22	7x13.5	251
007		1	7x6.8	152
008		1	7x6.8	27
009		14	7x13.5	152
010		14	7x13.5	27
011		1	7x13.5	251
012		1	7x13.5	251
013		12	7x13.5	64.5
014		1	7x13.5	251
015		1	7x13.5	431
016		14	7x13.5	431
017		1	7x13.5	471
018		1	7x6.7	471
019		1	7x13.5	57
020		1	7x13.5	292
021		14	7x13.5	57
022		1	7x13.5	292
023		9	7x13.5	292
024		1	7x13.5	292
025		1	7x13.5	154
026		3	7x13.5	91
027		2	7x13.5	154
028		1	7x13.5	471
029		1	7x6.7	471
Kood	Saun 2.7	Materjal	File Saun 2.7.dwg	Leht 1/2

Pos	Drawing Saun 2.7	Number	Profile (cm)	Length (cm)		
W1-1		1				
W2-1		1				
W3-1		1				
AR1	ALUSRAAM-BASE FRAME 	2	10x10	409		
AR2	ALUSRAAM-BASE FRAME 	3	10x10	229		
AR3	ALUSRAAM-BASE FRAME 	3	10x10	209		
AR4	ALUSRAAM-BASE FRAME 	8	5x10	209		
PR1	PÕHIPÄRLINID-CEILING BEAMS 	2	4.5x14.5	471		
PR2	PÕHIPÄRLINID-CEILING BEAMS 	1	4.5x14.5	471		
	PÕRANDALAUD-FLOORBOARD 	40	11.2x2.8	194		
	KATUSELAUD-ROOFBOARD 	106	9x1.8	149.9		
	LIIST 		2x4	16.4		
	OTSALAUD-BOARDS FOR GABLE 	4	2.1x14	199.9		
	RÄÄSTALAUD-BOARDS FOR EAVES 	2	2.1x12	481		
	RÄÄSTALIIST-SLAT FOR EAVES 	2	4.5x4.5	491		
SP1	Salapulk 	64	1.5x1.5	25		
SP2	Salapulk 	8	1.5x1.5	18		
	WINDOW 120x88	1				
	WINDOW 45x45	1				
	DOOR 70x197	1				
	DOOR 80x197	1				
Kood	Saun 2.7	Materjal	File	Saun 2.7.dwg	Leht	2/2

1 tk.		17 (4710)							13 (645)
1 tk.		18 (4710)							13 (645)
1 tk.		28 (4710)							13 (645)
1 tk.		29 (4710)							13 (645)
1 tk.		15 (4310)						5 (1062)	
1 tk.		16 (4310)						5 (1063)	
1 tk.		16 (4310)						5 (1062)	
3 tk.		16 (4310)						26 (910)	
1 tk.		16 (4310)						13 (645)	8 (270)
7 tk.		16 (4310)						13 (645)	10 (270)
1 tk.		16 (4310)						19 (570)	6 (509)
1 tk.		20 (2920)				25 (1540)		21 (570)	10 (270)
1 tk.		22 (2920)				27 (1540)		21 (570)	10 (270)
1 tk.		23 (2920)				27 (1540)		21 (570)	10 (270)
1 tk.		23 (2920)				7 (1520)		21 (570)	10 (270)
3 tk.		23 (2920)				9 (1520)		21 (570)	10 (270)
4 tk.		23 (2920)				9 (1520)		21 (570)	
1 tk.		24 (2920)				9 (1520)		21 (570)	
1 tk.		1 (2510)				1 (2510)			
11 tk.		2 (2510)				2 (2510)			
1 tk.		3 (2510)				3 (2510)			
1 tk.		3 (2510)				11 (2510)			
1 tk.		12 (2510)				14 (2510)			
2 tk.		9 (1520)				9 (1520)			21 (570)
1 tk.	6 (509)	6 (509)	6 (509)	6 (509)	6 (509)	4 (509)	4 (509)	4 (509)	4 (509)
1 tk.	4 (509)								

TOORIKU PIKKUS 5.4 m KOKKU 50 TÜKKI
DETAILIDE ARV 139 TÜKKI

Code	Saun 2.7	Sheet	1/1
Drawing	OPTIMEERIMINE 93.9%	Scale	
Material	5.4m 7x13.5	Date	04.04.2017
Drew	M.Mere	File	Saun 2.7.dwg

①	002	002
	009	009
	009	002
	002	021 002

②	016	009
	002	021 010 002
	001	010 007 009
	002	021 008 001
	023	021 002
	012	021 022
	020	019 002
	009	015

③	027	016
	002	010 009 009
	002	021 010 002
	023	009 009
	009	009 023
		016 010 013 013
	013 021 010	016
	023	021 002

④	016	027
	025	009 010 002
		016 010 021 013
	002	021 023
		016 010 021 013
	011	021 023
	023	021 014
	009	016

⑤	003	021	024
	002	013	002
	002	013 010	003
	003	010 013	002
	026 004 010	016	
		016 010 004 026	
	026 004 010	016	
	023	004	002

PACKAGED BY MONTAGE ORDER
 Length: 6 m
 Width: 1.12 m
 Height: 0.55 m

Code	Saun 2.7	Sheet	1/2
Drawing	PAKK Nr. 1 (96.1%)	Scale	
Material	7x13.5	Date	04.04.2017
Drew	M.Mere	File	Saun 2.7.dwg

6

	023	004	002
005	006	016	
	016	006	005
013	006	018	
	029	006	013
013	006	017	
	028	006	013
005	004	016	

PACKAGED BY MONTAGE ORDER
Length: 6 m
Width: 1.12 m
Height: 0.55 m

Code	Saun 2.7	Sheet	2/2
Drawing	PAKK Nr. 1 (96.1%)	Scale	
Material	7x13.5	Date	04.04.2017
Drew	M.Mere	File	Saun 2.7.dwg