

Nimi	Eva 50	Materjal	50x110
Joonis	3D plan	Mõõtmine	
Estonian Log Cabins OÜ	Leht 1	Kuup.	10.12.2020

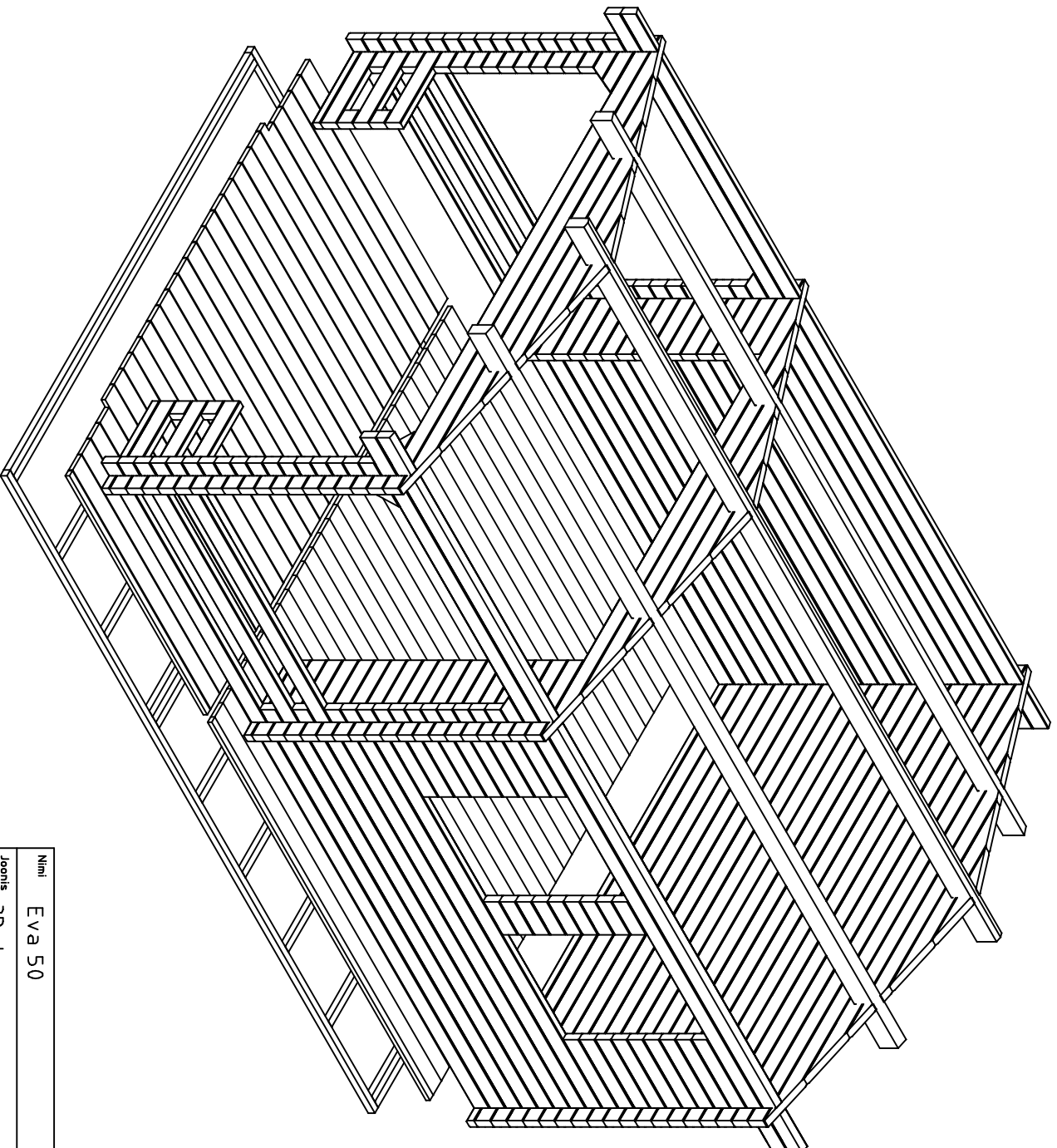

Nimi	Eva 50	Materjal	50x110
Joonis	3D plan	Mõõtühik	
Estonian Log Cabins OÜ		Leht	2
		Kuup.	10.12.2020

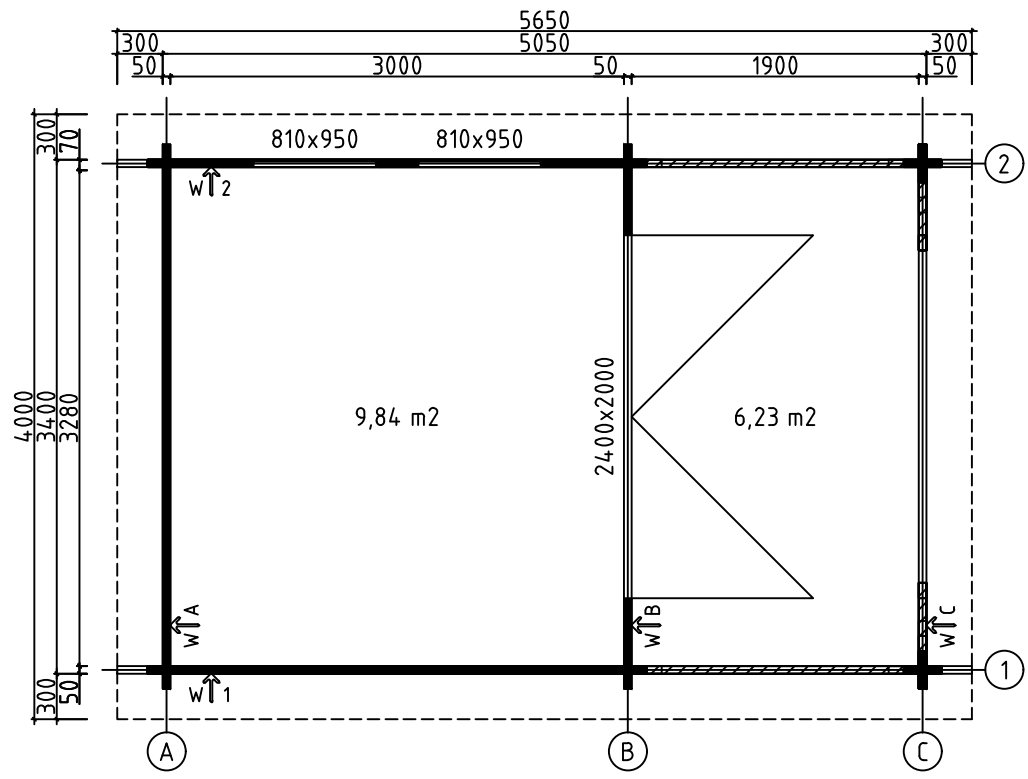

Nimi	Eva 50	Materjal	50x110
Joonis	GROUNDPLAN	Mõõtkava	1:50
Estonian Log Cabins OÜ		Leht	3
		Kuup.	10.12.2020

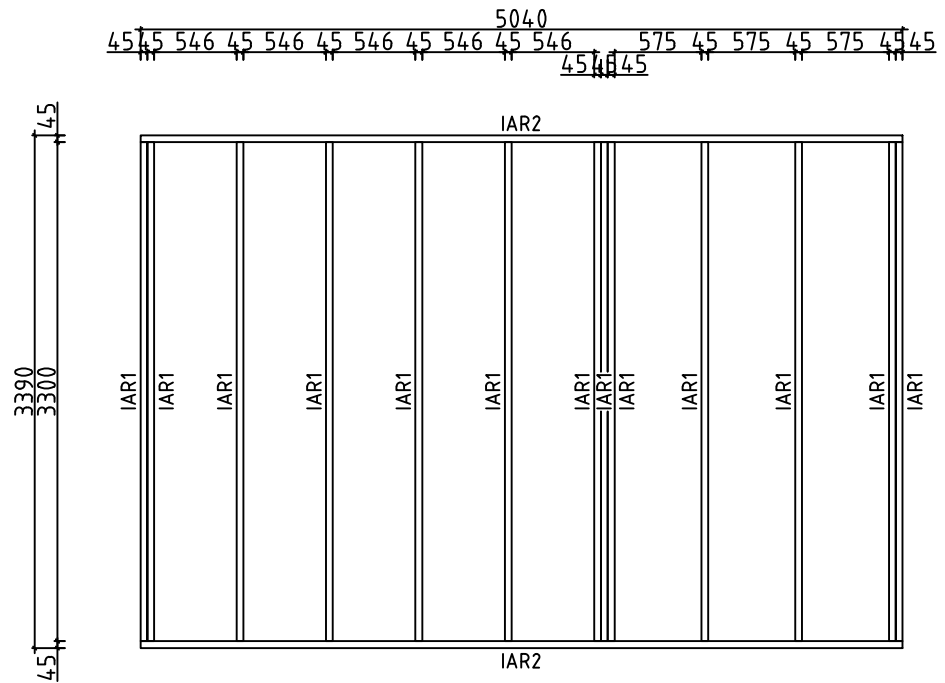

Nimi	Eva 70	Materjal	45x45
Joonis	FLOORBEAMS	Mõõtkava	1:50
Estonian Log Cabins OÜ	Leht 4	Kuup.	10.12.2020

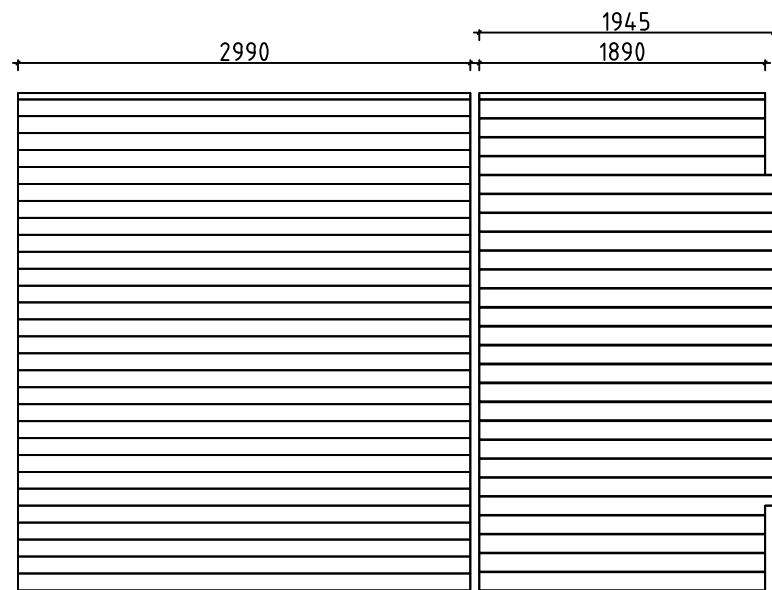

Nimi	Eva 70	Materjal	112x28, 120x28
Joonis	FLOORBOARD	Mõõtkava	1:50
	Estonian Log Cabins OÜ	Leht	5
		Kuup.	10.12.2020

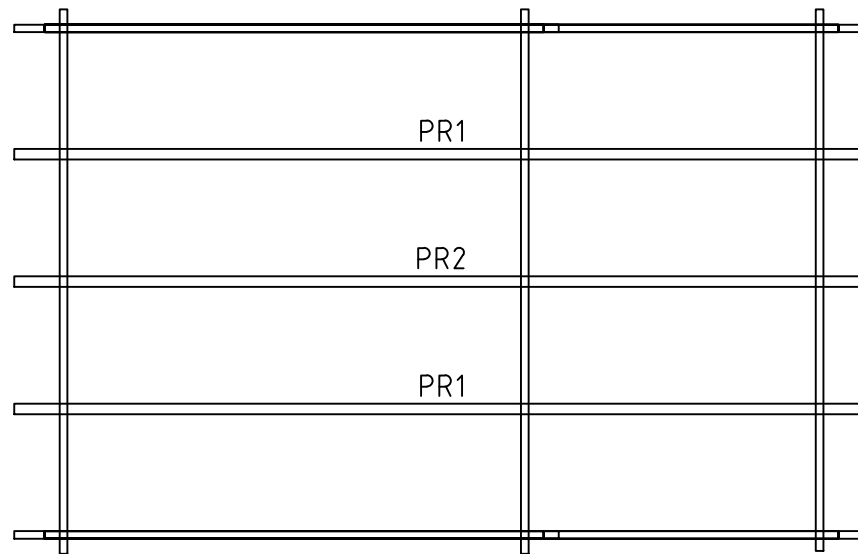

Nimi	Eva 70	Materjal	70x145
Joonis	ROOFBEAMS	Mõõtkava	1:50
Estonian Log Cabins OÜ		Leht	6
		Kuup.	10.12.2020

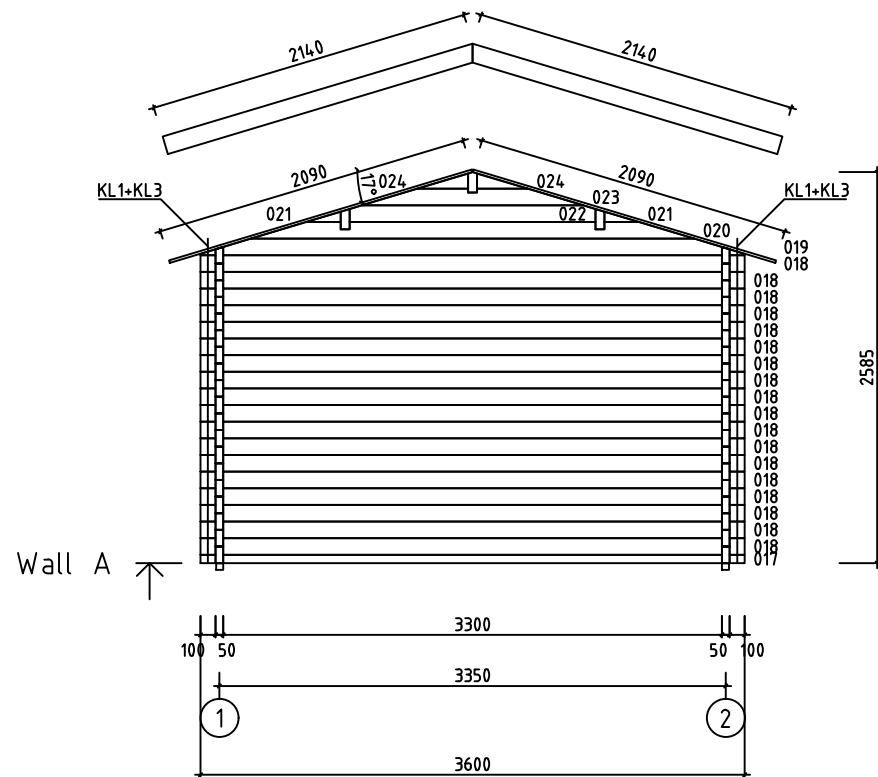

Nimi	Eva 50	Materjal	50x110
Joonis	WALL A	Mõõtkava	1:50
Estonian Log Cabins OÜ		Leht	7
		Kuup.	10.12.2020

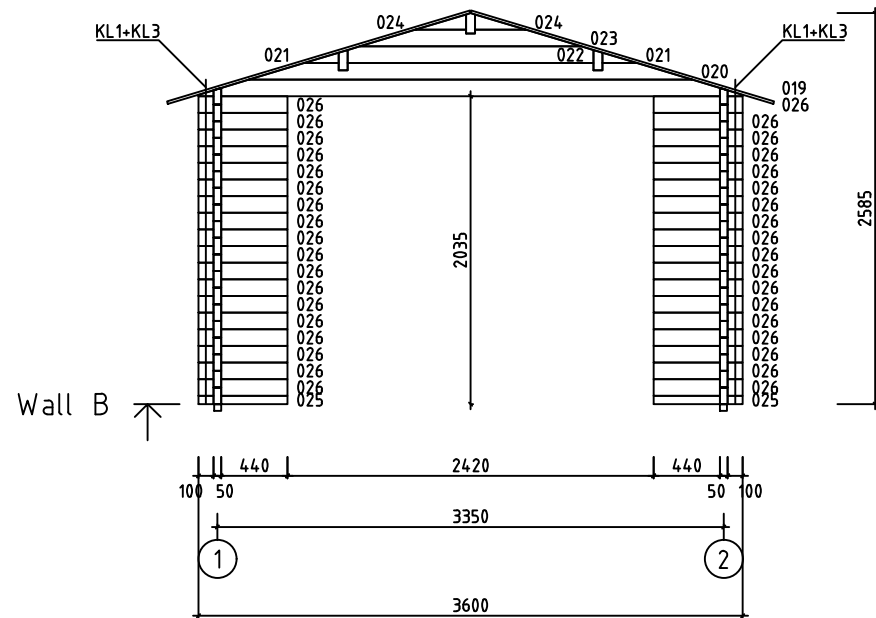

Nimi	Eva 50	Materjal	50x110
Joonis	WALL B	Mõõtkava	1:50
Estonian Log Cabins OÜ		Leht	8
		Kuup.	10.12.2020



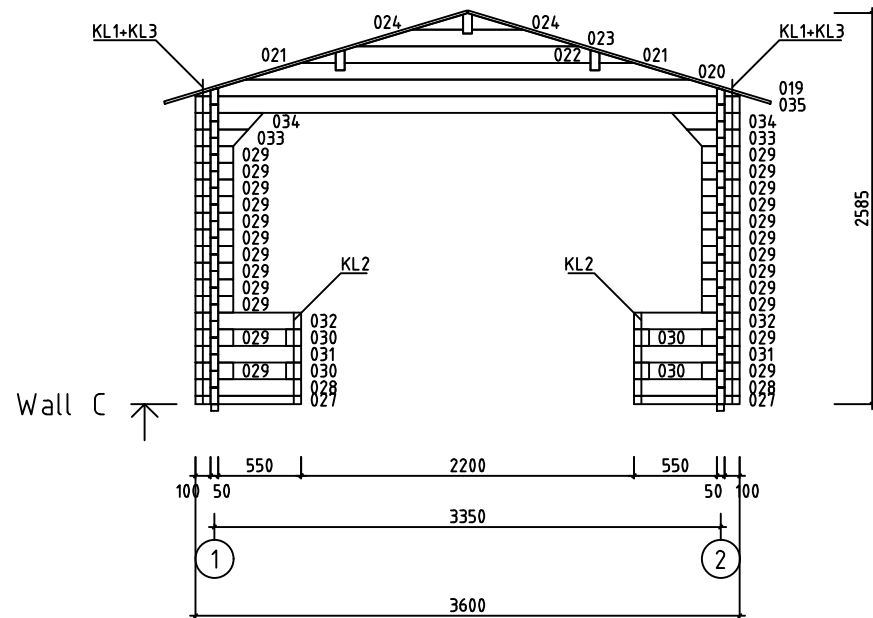



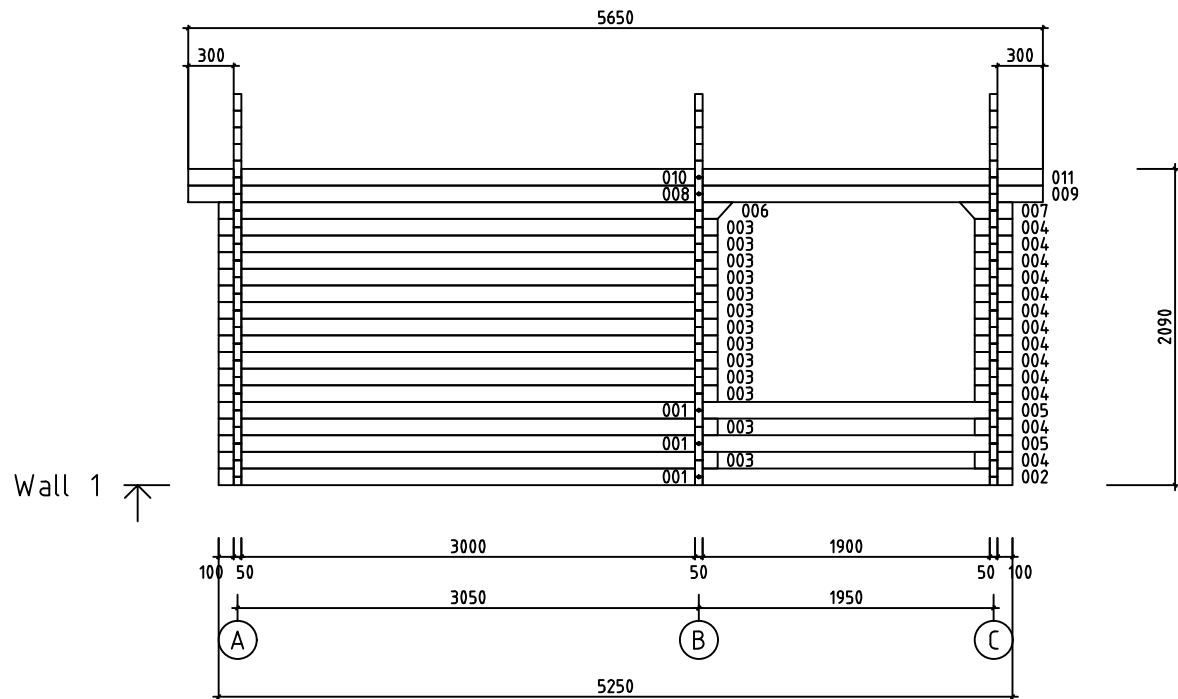



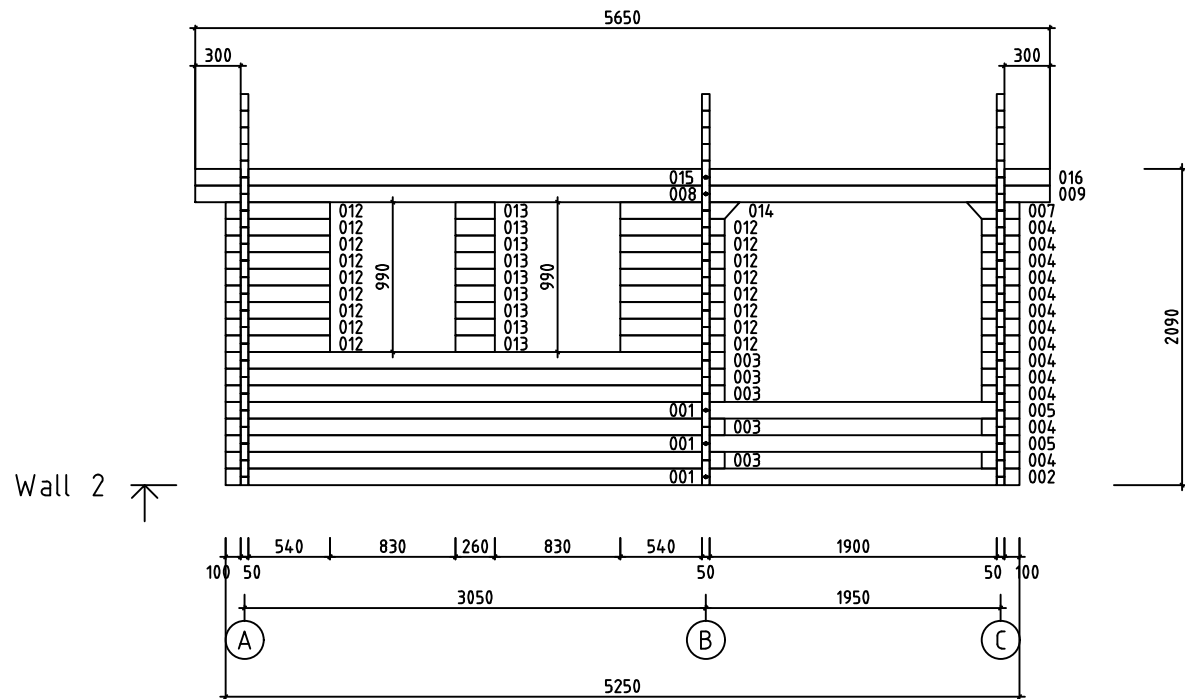



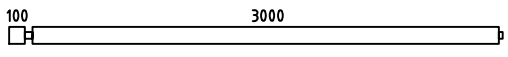
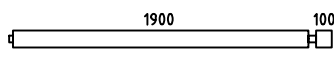
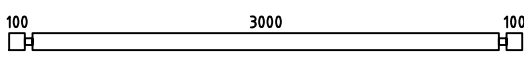

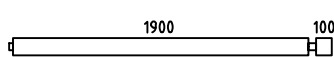
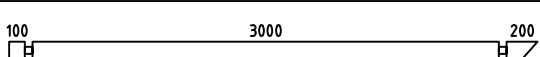
Nimi	Eva 50	Materjal	50x110
Joonis	WALL C	Mõõtkava	1:50
Estonian Log Cabins OÜ		Leht	9
		Kuup.	10.12.2020

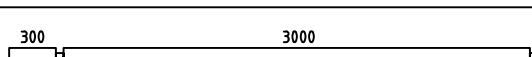
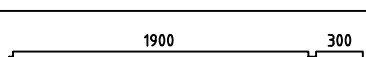
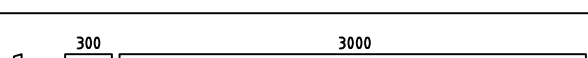
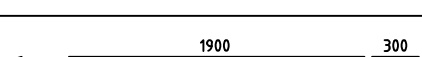
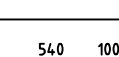

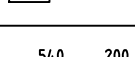
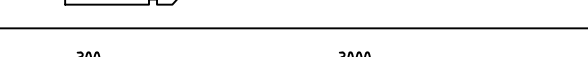
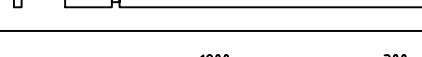
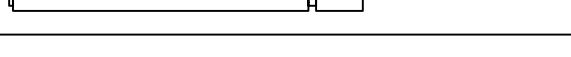
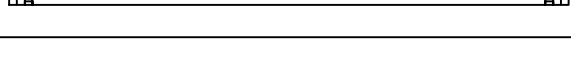

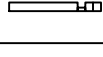
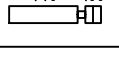





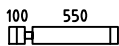

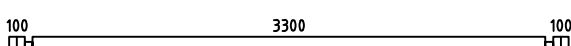
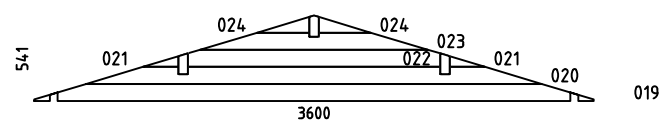
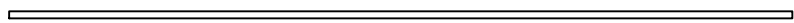
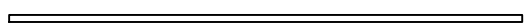



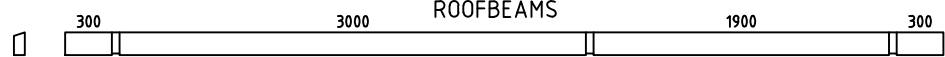
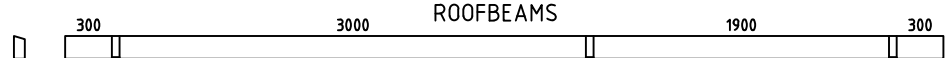
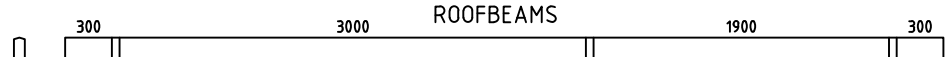

Nimi	Eva 50	Materjal	50x110
Joonis	WALL 1	Mõõtkava	1:50
Estonian Log Cabins OÜ		Leht	10
		Kuup.	10.12.2020



Nimi	Eva 50	Materjal	50x110
Joonis	WALL 2	Mõõtkava	1:50
Estonian Log Cabins OÜ		Leht	11
		Kuup.	10.12.2020

Pos	Specification	PCS	Profile (mm)	L (mm)
001		6	50x110	3175
002		2	50x110	2075
003		18	50x110	3300
004		26	50x110	250
005		4	50x110	2075
006		1	50x110	3400
007		2	50x110	350
008		2	50x110	3375
009		2	50x110	2275
010		1	50x110	3375
011		1	50x110	2275
012		17	50x110	690
013		9	50x110	260
014		1	50x110	790
015		1	50x110	3375
016		1	50x110	2275
017		1	50x55	3600
018		18	50x110	3600
025		2	50x55	590
026		36	50x110	590
027		2	50x55	700
028		2	50x110	700
029		24	50x110	250
030		4	50x110	100
031		2	50x110	700

Pos	Specification	PCS	Profile (mm)	L (mm)
032		2	50x110	700
033		2	50x110	350
034		2	50x110	450
035		1	50x110	3600
WA-1 WB-1 WC-1		3	50x541	3600
IAR2	FLOORBEAMS IMPREGNATED 	2	45x45	5040
IAR1	FLOORBEAMS IMPREGNATED 	13	45x45	3300
L4	BOARD 	2	95x18	2670
L2	BOARD 	4	95x18	1990
L3	BOARD 	4	95x18	1080
L1	BOARD 	8	95x18	1075
L5	BOARD 	4	95x18	790
PR3	ROOFBEAMS 	1	70x145	5650
PR1	ROOFBEAMS 	1	70x145	5650
PR2	ROOFBEAMS 	1	70x145	5650
	FLOORBOARD	30+1	112x28	2990
	TERRACE BOARD IMPREGNATED	18+1	120x28	1945
	TERRACE BOARD IMPREGNATED	9	120x28	1890
	ROOFBOARD	84+2	135x18	2090
	FLOOR FILLET		13x57	13
	GABLE BOARD	4	18x120	2140
	EAVE BOARD	2	18x120	5650
	EAVE SLAT	2	45x45	5650
	WALLBEAMS CONNECTING METAL 40x30	10		
House Eva 50		Material	File Eva 50.dwg	Sheet 13

Pos	Specification	PCS	Profile (mm)	L (mm)		
	CORNER BRACKET 50x50x35 Nurgik 50x50x35	20				
KL1	SCREW JOINT M10 	6		2000		
KL2	SCREW JOINT M10 	2		605		
KL3	SCREW JOINT M10 	6		100		
	NUT M10 	8				
	WASHER D10 	8				
	NUT M10 	6				
	NUT M10 	8				
	WINDOW 810x950	2				
	DOOR 2400x2000	1				
House	Eva 50	Material	File	Eva 50.dwg	Sheet	14