

Nimi	Sammy 5 50	Materjal	50x110
Joonis	3D plan	Mõõtühik	
Estonian Log Cabins OÜ	Leht 1	Kuup.	04.01.2021

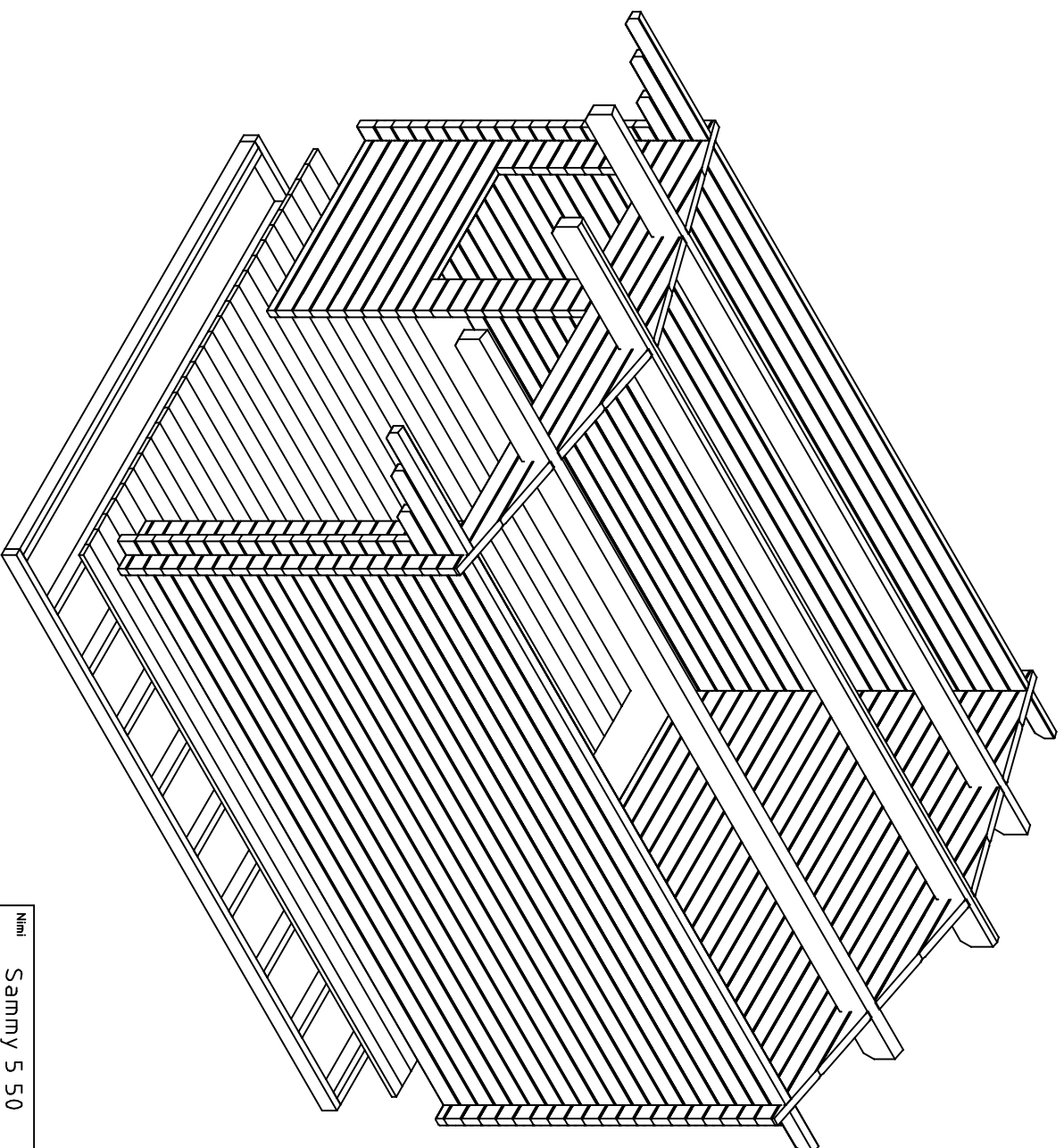

Nimi	Sammy 5 50	Materjal	50x110
Joonis	3D plan	Mõõtühik	
Estonian Log Cabins OÜ	Leht 2	Kuup.	04.01.2021

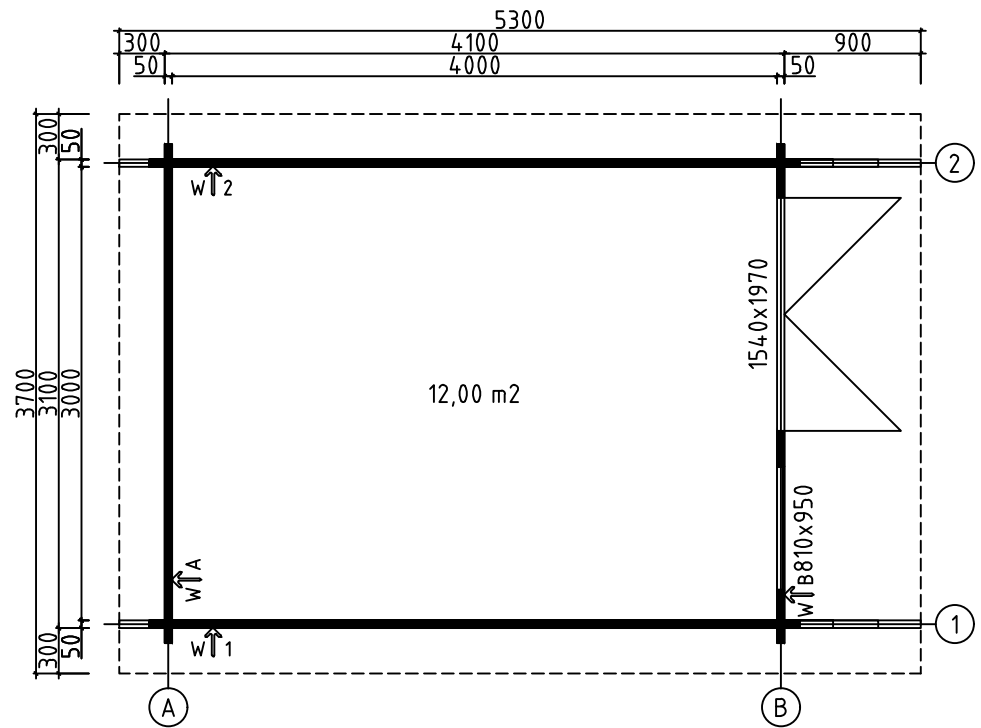

Nimi	Sammy 5 50	Materjal	50x110
Joonis	GROUNDPLAN	Mõõtkava	1:50
Estonian Log Cabins OÜ		Leht	3
		Kuup.	04.01.2021

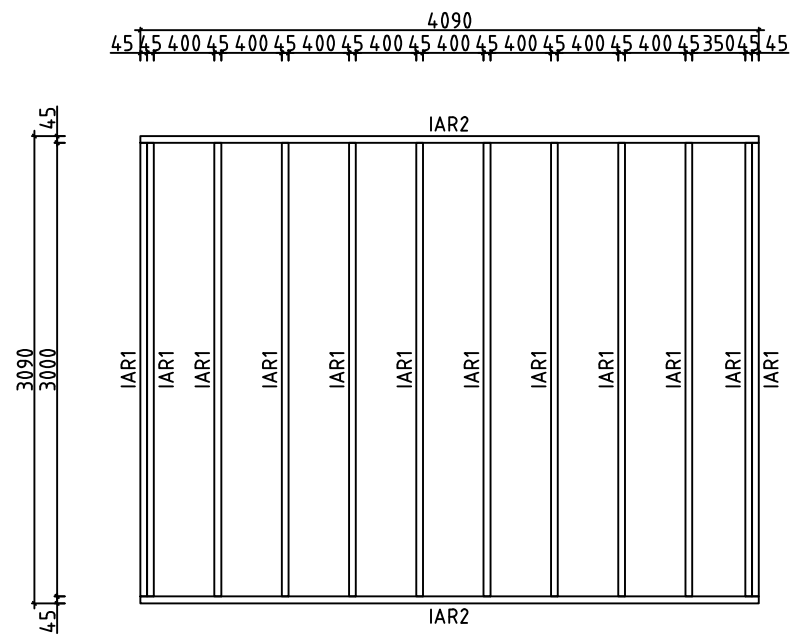

Nimi	Sammy 5 50	Materjal	45x95
Joonis	FLOORBEAMS	Mõõtkava	1:50
Estonian Log Cabins OÜ		Leht	4
		Kuup.	04.01.2021

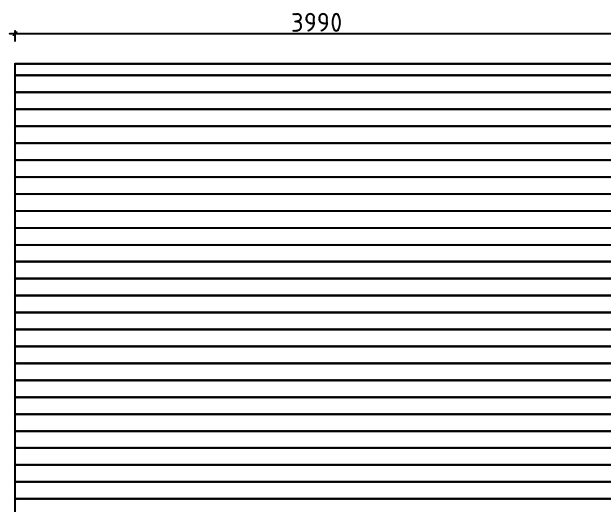

Nimi	Sammy 5 50	Materjal	112x28
Joonis	FLOORBOARD	Mõõtkava	1:50
Estonian Log Cabins OÜ	Leht 5	Kuup.	04.01.2021

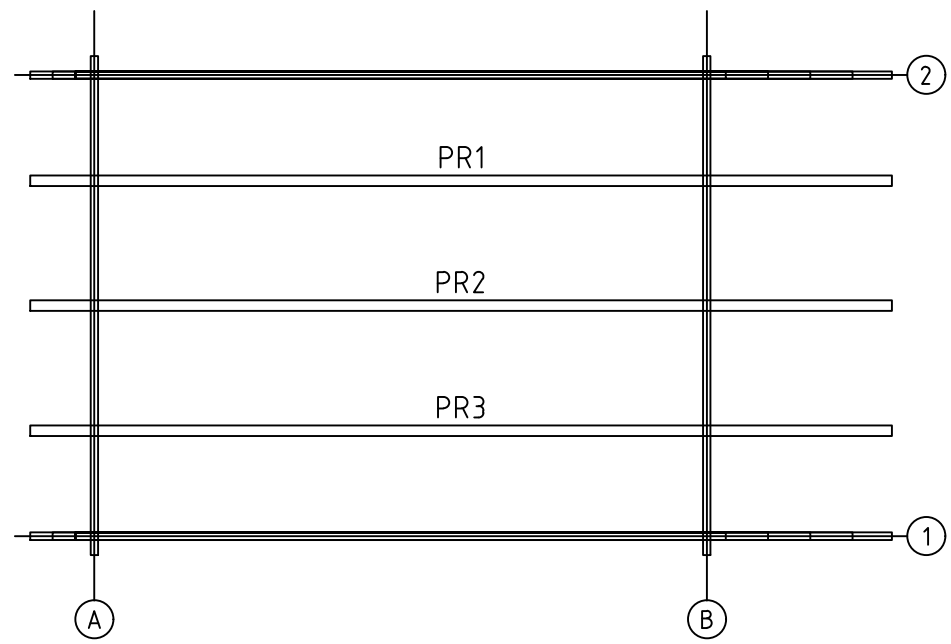

Nimi	Sammy 5 50	Materjal	70x195
Joonis	ROOFBEAMS	Mõõtkava	1:50
Estonian Log Cabins OÜ		Leht	6
		Kuup.	04.01.2021

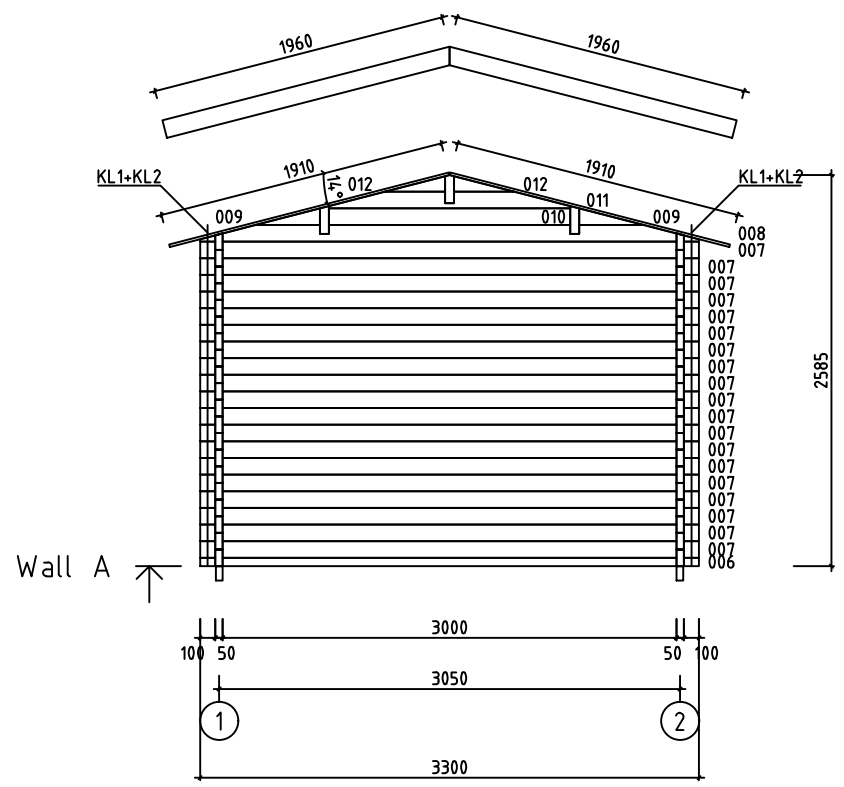

Nimi	Sammy 5 50	Materjal	50x110
Joonis	WALL A	Mõõtkava	1:50
Estonian Log Cabins OÜ		Leht	7
		Kuup.	04.01.2021

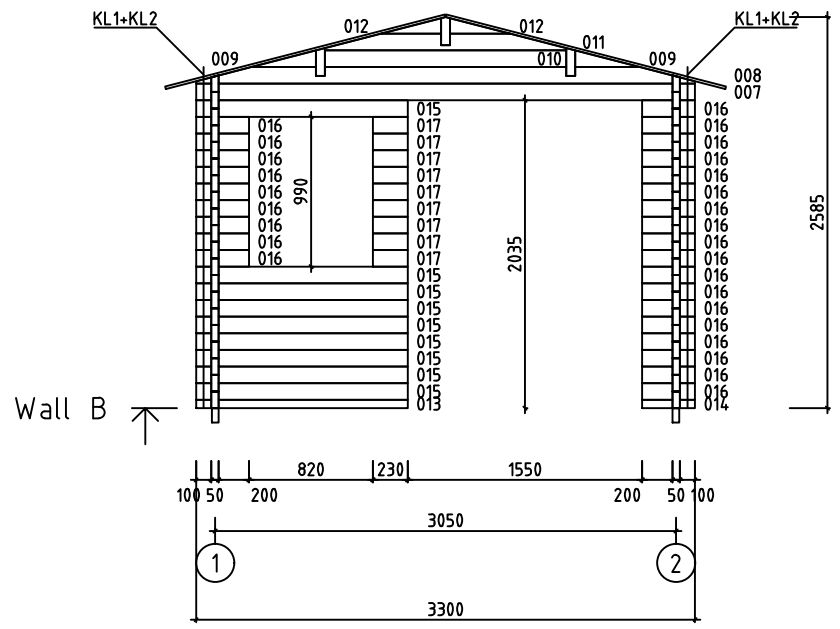

Nimi	Sammy 5 50	Materjal	50x110
Joonis	WALL B	Mõõtkava	1:50
Estonian Log Cabins OÜ	Leht 8	Kuup.	04.01.2021



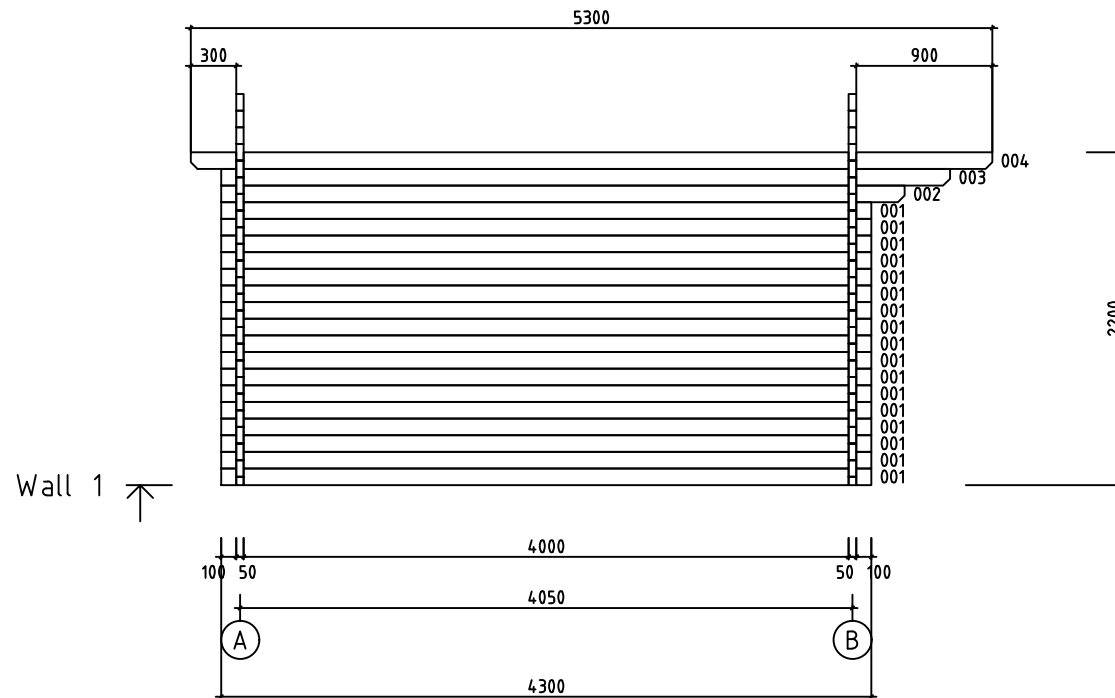



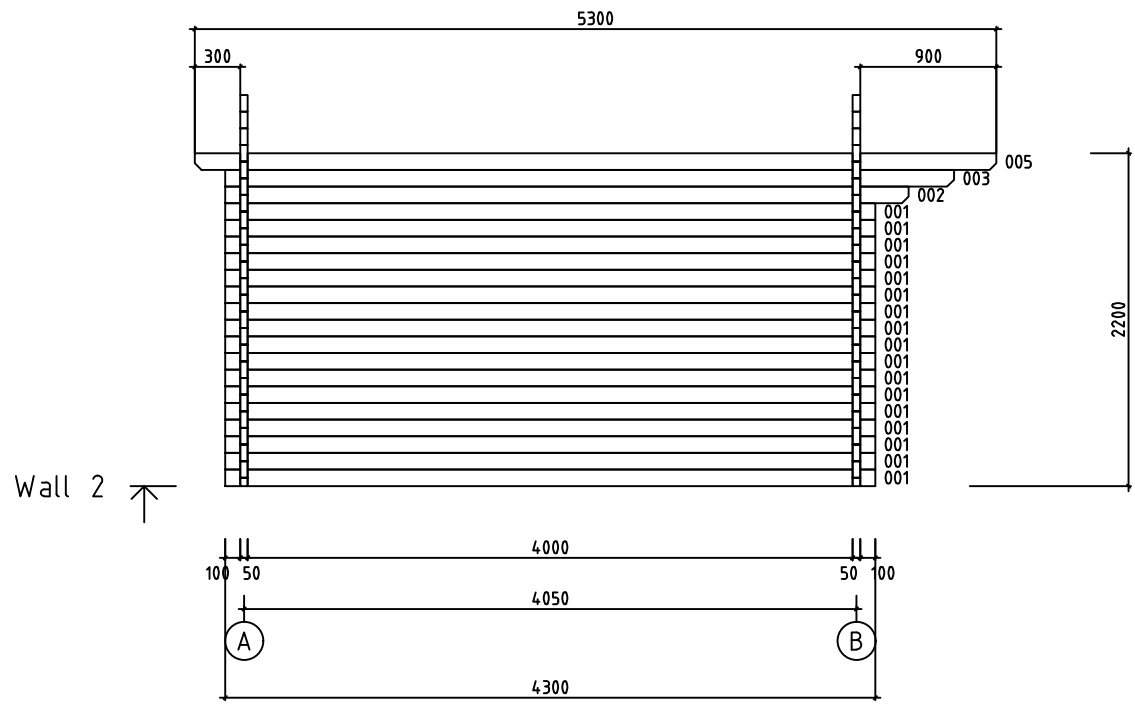





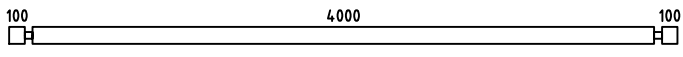
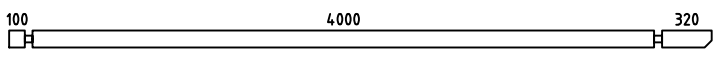
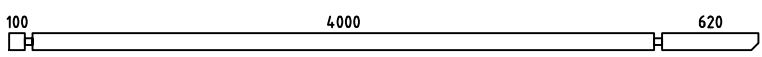
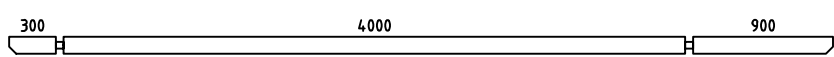
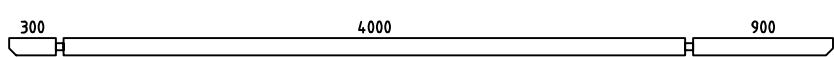
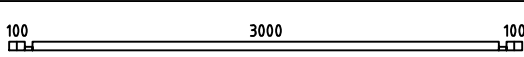
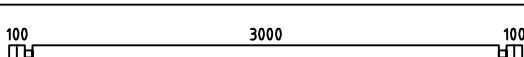
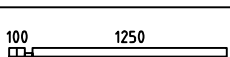

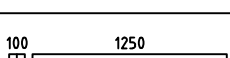

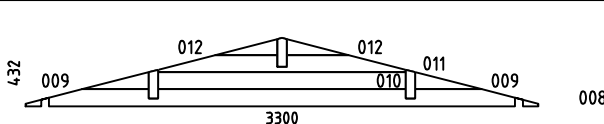

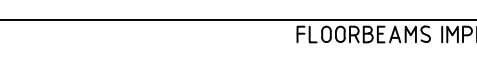
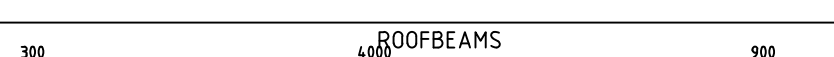
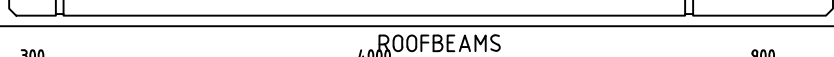
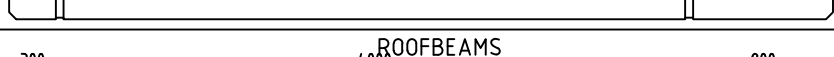
Nimi	Sammy 5 50	Materjal	50x110
Joonis	WALL 1	Mõõtkava	1:50
Estonian Log Cabins OÜ		Leht	9
		Kuup.	04.01.2021



Wall 2 ↗

Nimi Sammy 5 50		Materjal 50x110
Joonis WALL 2		Mõõtkava 1:50
Estonian Log Cabins OÜ	Leht 10	Kuup. 04.01.2021

Pos	Specification	PCS	Profile (mm)	L (mm)		
001		34	50x110	4300		
002		2	50x110	4520		
003		2	50x110	4820		
004		1	50x110	5300		
005		1	50x110	5300		
006		1	50x55	3300		
007		20	50x110	3300		
013		1	50x55	1400		
014		1	50x55	350		
015		9	50x110	1400		
016		27	50x110	350		
017		9	50x110	230		
WA-1 WB-1		2	50x432	3300		
IAR2	FLOORBEAMS IMPREGNATED 	2	45x95	4090		
IAR1	FLOORBEAMS IMPREGNATED 	12	45x95	3000		
PR3	ROOFBEAMS 	1	70x195	5300		
PR1	ROOFBEAMS 	1	70x195	5300		
PR2	ROOFBEAMS 	1	70x195	5300		
	FLOORBOARD	27+1	112x28	3990		
	ROOFBOARD	80+2	135x18	1910		
	FLOOR FILLET		13x57	14		
	GABLE BOARD	4	18x120	1960		
	EAVE BOARD	2	18x120	5300		
	EAVE SLAT	2	45x45	5300		
House	Sammy 5 50	Material	File	Sammy 5 50.dwg	Sheet	11

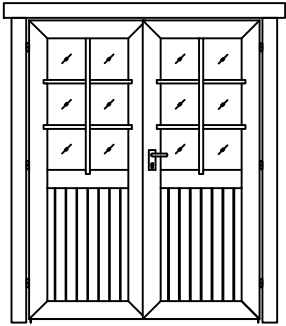
Pos	Specification	PCS	Profile (mm)	L (mm)		
	SCREWS 3.9x42 FOR ROOFBOARD	240				
	SCREWS 3.9x57 FOR FLOORBOARD	270				
	SCREWS 4.5x50 FOR GABLE BOARD, EAVE BOARD, EAVE SLAT, FLOOR FILLET	70				
	SCREWS 4.5x90 FOR FLOORBEAMS	60				
	SCREWS 4.5x90 FOR ROOFBEAMS, GABLE	22				
KL1	SCREW JOINT M10 	4		2000		
KL2	SCREW JOINT M10 	4		230		
	NUT M10 	4				
	WASHER D10 	4				
	NUT M10 	4				
	NUT M10 	4				
	WINDOW 	1	810	950		
	BOARD	2	95x18	1080		
	BOARD	4	95x18	1075		
	BOARD	2	95x18	790		
	SCREWS 3x40 FOR BOARD	24				
	DOOR 	1	1540	1970		
	BOARD	4	95x18	1960		
	BOARD	2	95x18	1810		
	SCREWS 3x40 FOR BOARD	24				
House	Sammy 5 50	Material	File	Sammy 5 50.dwg	Sheet	12