

Oreo XL  
GROUNDPLAN

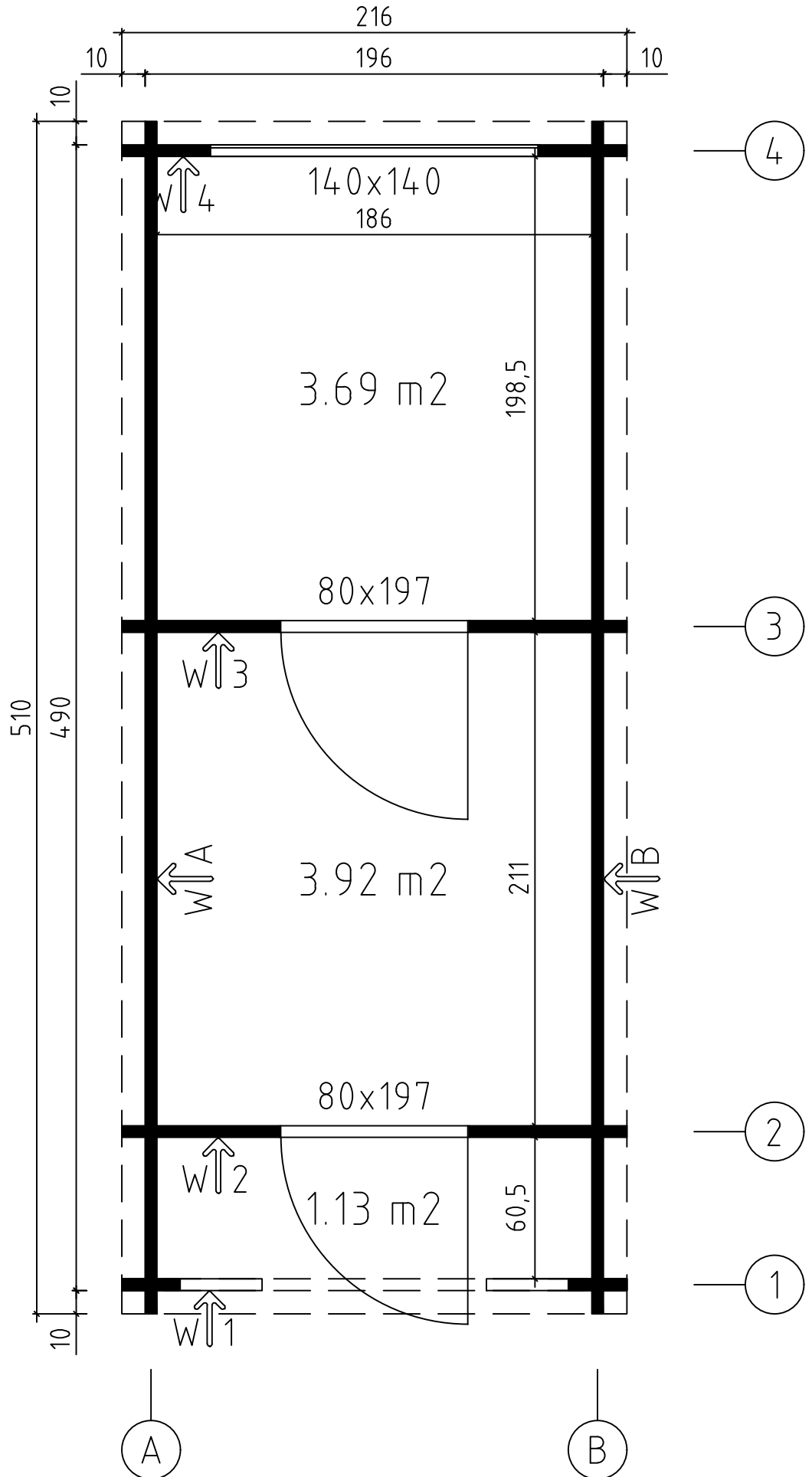

Oreo XL  
FOUNDATION

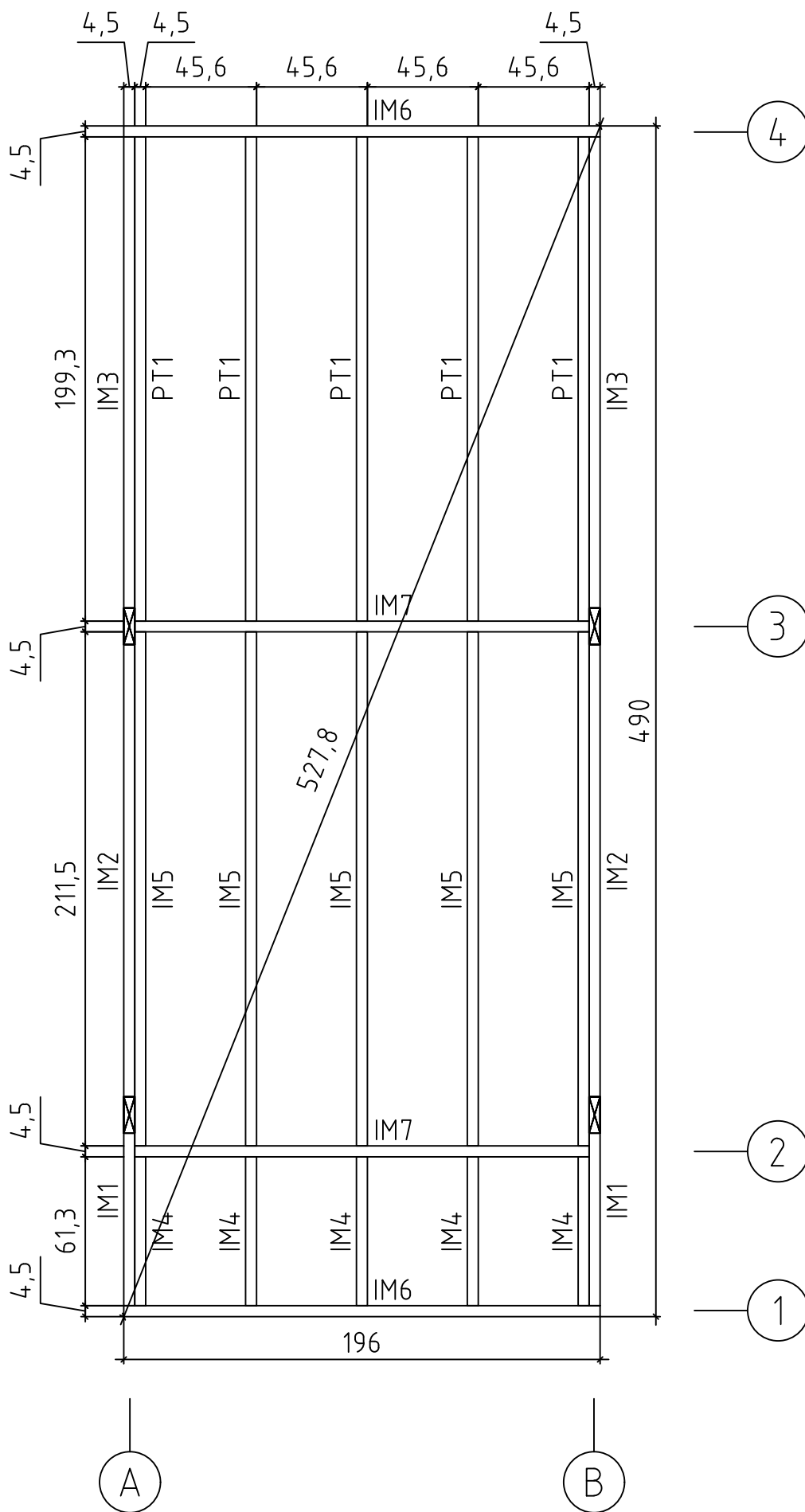

Oreo XL  
FLOOR BOARDS  
TERRACE BOARDS

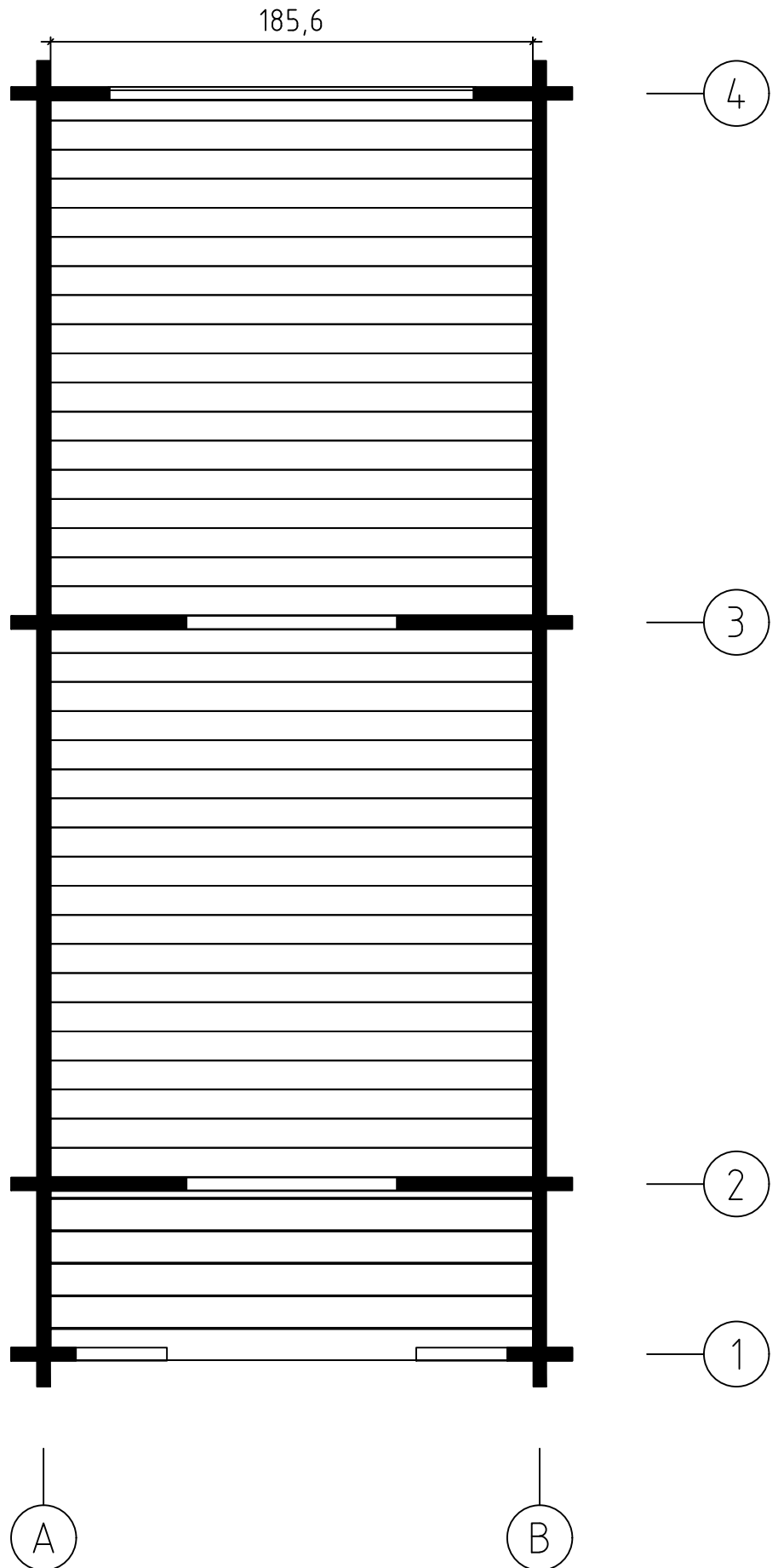





Oreo XL

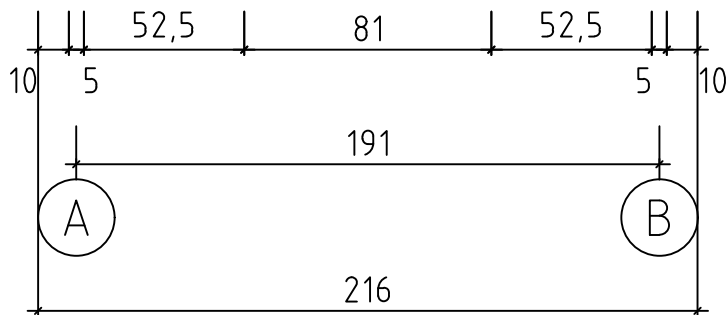
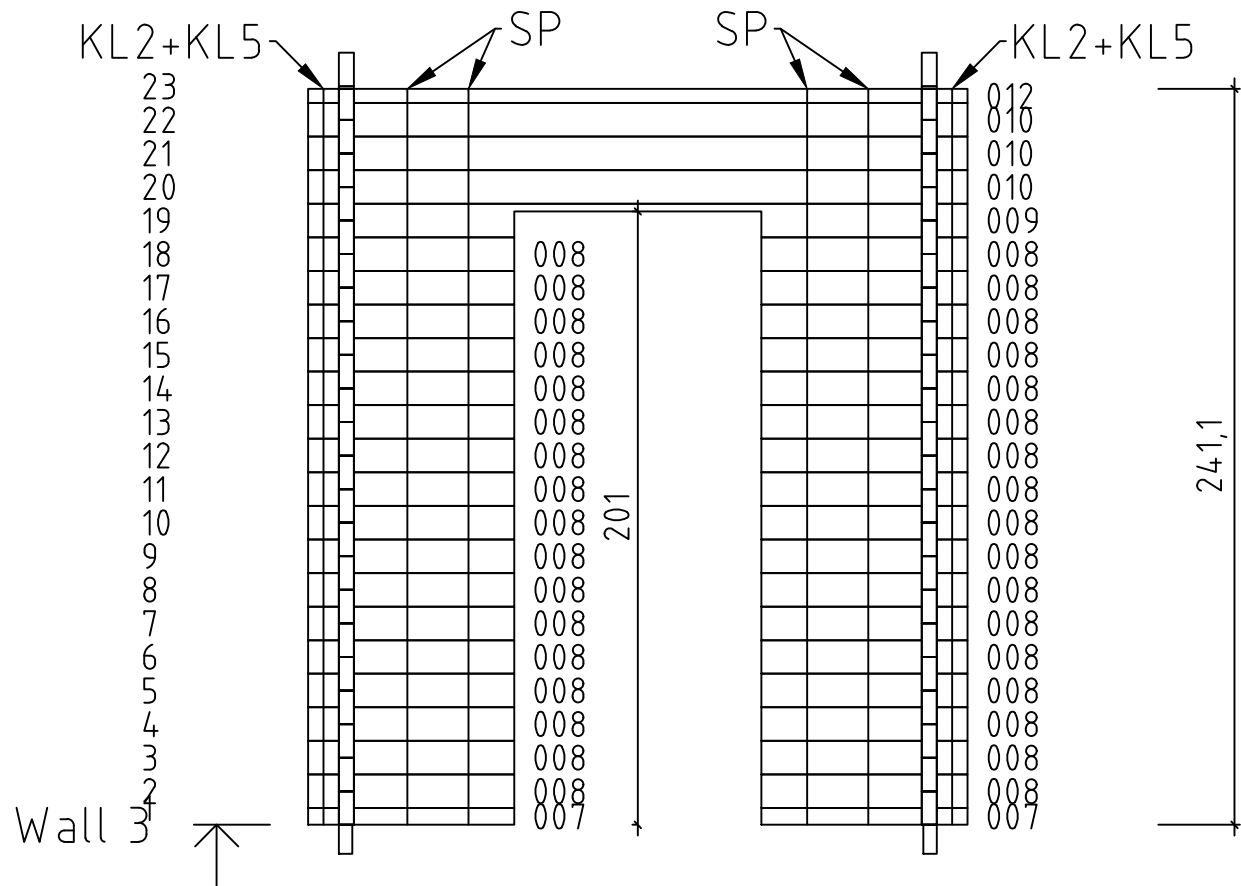



Oreo XL

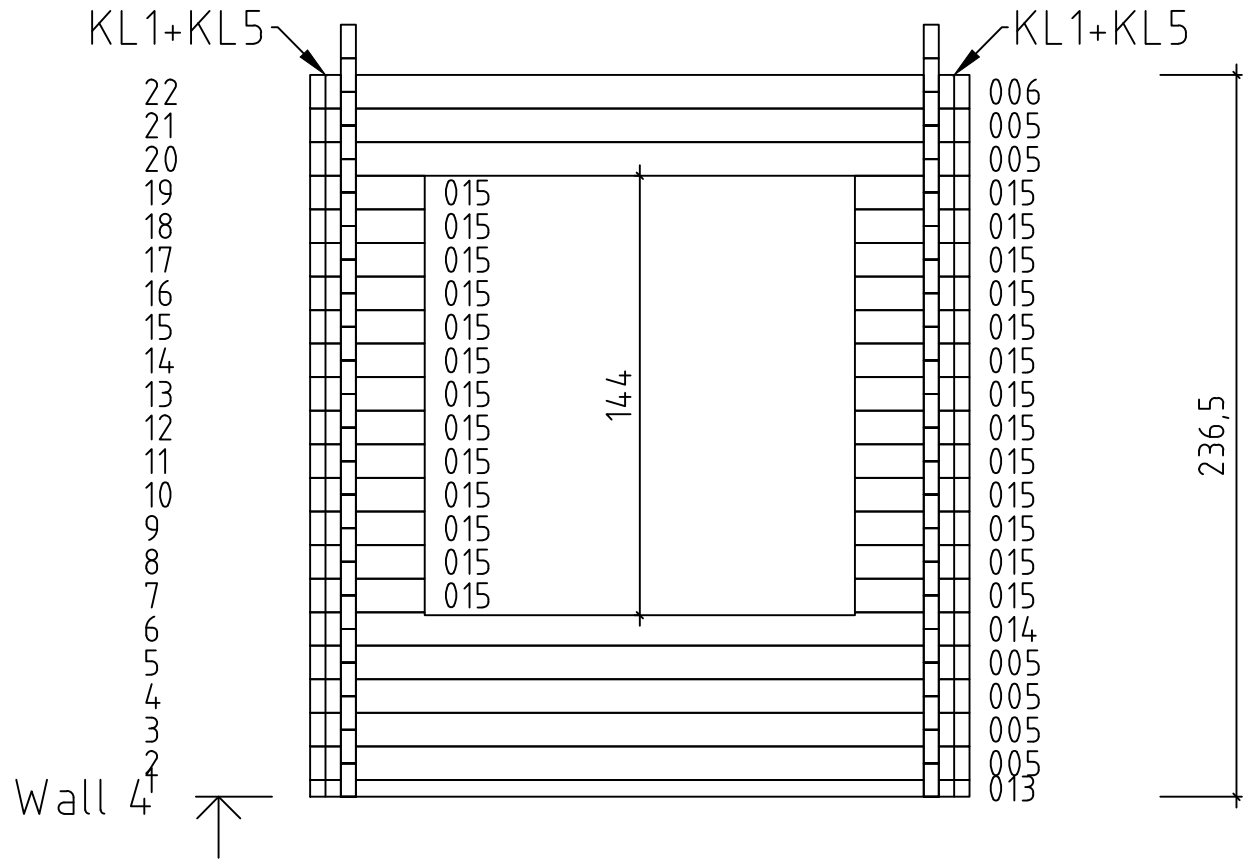



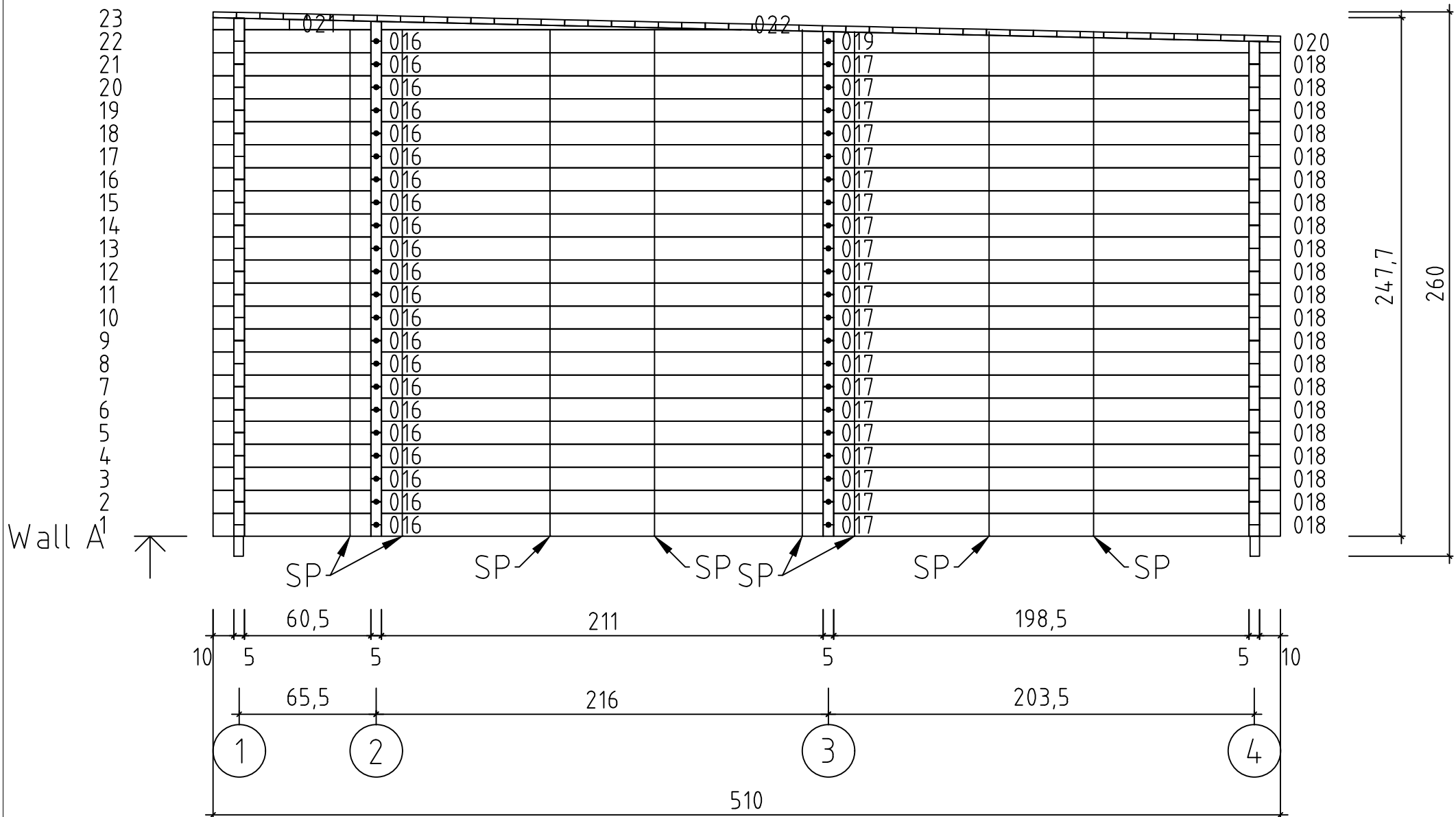



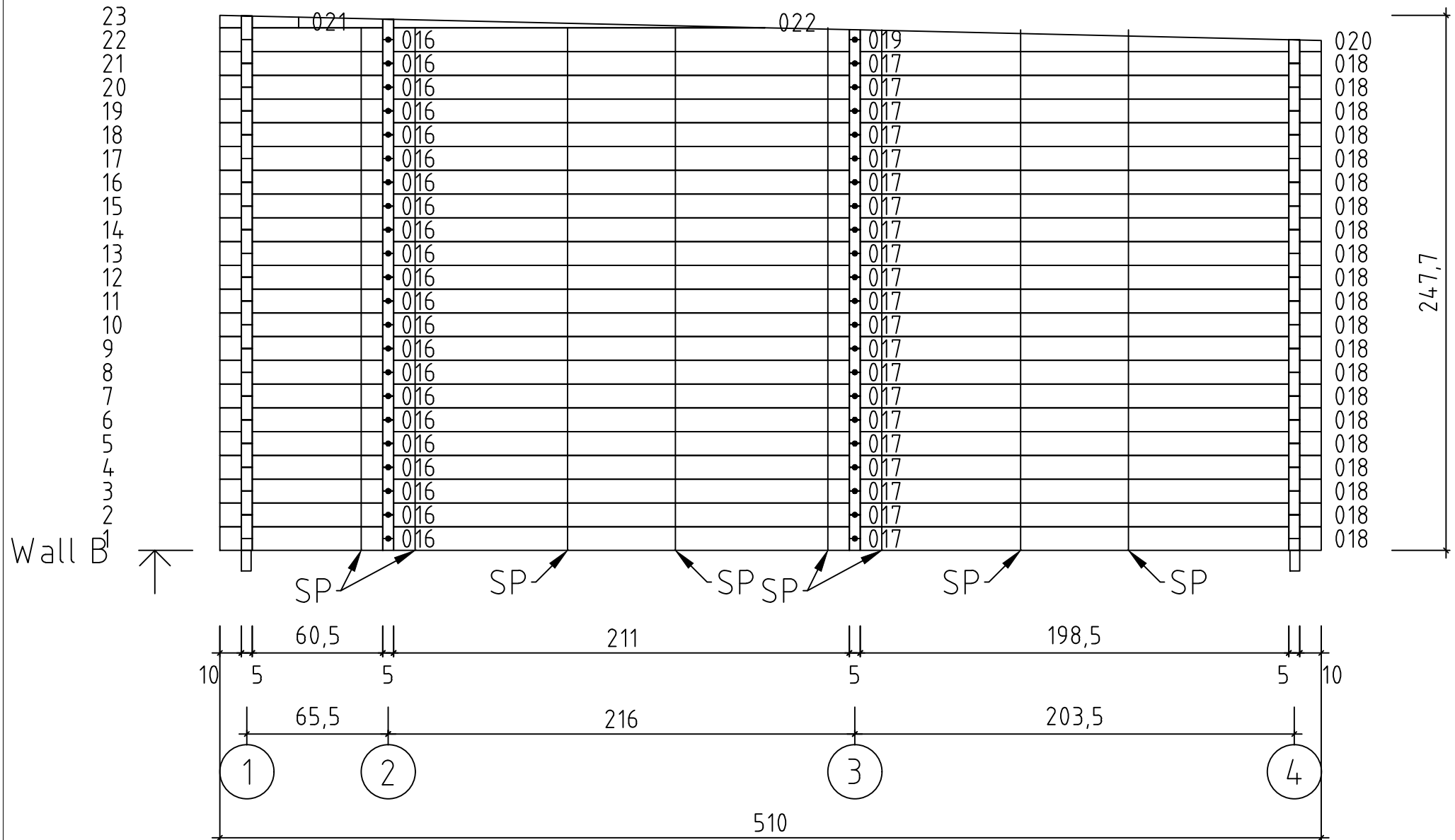





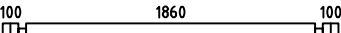
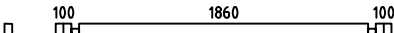
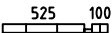
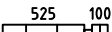
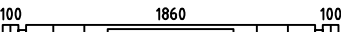
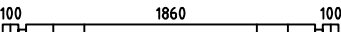
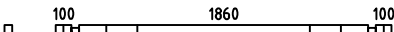
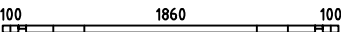
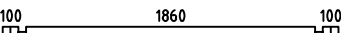
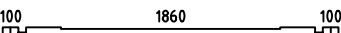

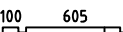
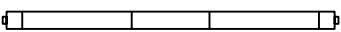
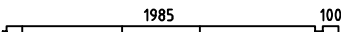
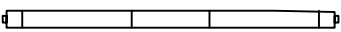
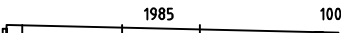



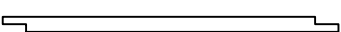

Oreo XL

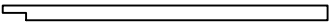
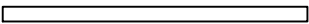
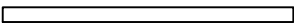
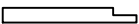

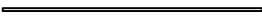
Oreo XL



Pos	Oreo XL Piece list	Q.	Profile (mm)	Length (mm)
001		2	50x55	600
002		8	50x110	600
003		2	50x110	600
004		30	50x110	250
005		7	50x110	2160
006		2	50x110	2160
007		4	50x55	675
008		68	50x110	675
009		2	50x110	2160
010		6	50x110	2160
011		1	50x95	2160
012		1	50x46	2160
013		1	50x55	2160
014		1	50x110	2160
015		26	50x110	375
016		44	50x110	780
017		42	50x110	2160
018		42	50x110	2160
019		2	50x110	2160
020		2	50x100	2160
021		2	50x57	365
022		2	50x49	2160
PT1	 FLOOR BEAMS	5	45x95	1993
IM2	 FOUNDATION FRAME	2	45x95	2160
IM5	 FOUNDATION FRAME	5	45x95	2115

Pos	Oreo XL Piece list	Q.	Profile (mm)	Length (mm)
IM3	FOUNDATION FRAME 	2	45x95	2090
IM6	FOUNDATION FRAME 	2	45x95	1960
IM7	FOUNDATION FRAME 	2	45x95	1870
IM1	FOUNDATION FRAME 	2	45x95	860
IM4	FOUNDATION FRAME 	5	45x95	613
L1	COVERING MOULDING 	8	95x18	1960
L4	COVERING MOULDING 	2	95x18	1670
L2	COVERING MOULDING 	4	95x18	1525
L5	COVERING MOULDING 	2	95x18	1380
L3	COVERING MOULDING 	4	95x18	1070
	FLOOR BOARDS 	37	112x28	1856
	TERRACE BOARDS 	6	120x28	1856
	ROOF BOARDS 	46	112x28	2160
	FLOOR FILLET			16 m.
KL1	TREADED ROD	2		395
KL2	TREADED ROD	2		440
KL3	TREADED ROD	2		490
KL4	TREADED ROD	2		505
KL5	TREADED ROD	8		2000
	EAVES BOARD	2	18x120	2160
SP	HIDDEN FIXING			59 m.
	GABLE MOULDING	2	18x120	825
	GABLE MOULDING	4	18x120	2160
	WINDOW 1400x1400	1		
	DOOR 800x1970	2		